

APWIN

APWIN INSTALLATION & GETTING STARTED
FOR SYSTEM TWO CASCADE

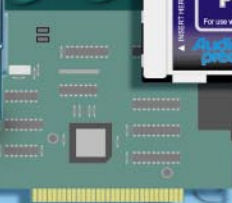

ency
eponse

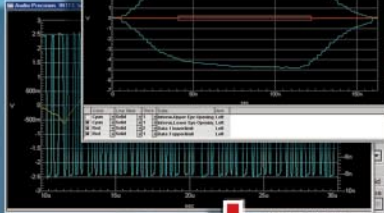
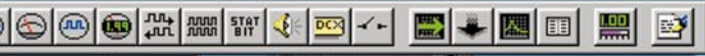

Formal Dual VSR Bus 2im T10 Drive
Sample Rate: 50.000 kHz
Voltage: 120.8 mVpp
Resolution: 24 Bits
Delay: 400.0 ns
Invert Out: 400.0 ns
DeEmphasis: Off
Scale Res. by: Measured Rate
Rate Res: 40.000 kHz
Channel A: 100.0 mV, 100.0 Hz, 1/2 Pk-Pk
Mode: Active Bit
Erase Flags: confidence lock coding parity
Filter Measurement: Off
Filter Generation: Off
Filter Curve: Off
Filter: 70Hz to 1000 Hz
Pk (P Avg)

Win: Show (2/1/1) Checked Burst
Presampling: 0.000 Hz
Start On: 10 Cycles
Intensity: 80 Cycles
11/13/97 05:39:26
Digital Analyze
ANALYZE: DSP Audio Analyser (analysis)
CH A: Input: Digital @ VSR, Chopped
AC Coupled: - Coupling: AC Coupled
Level: 20.00 dBFS
Freq: 100.0 Hz
Range: 100.0 dBFS
Reading: 0.000 Vrms
Measurement Function: Amplitude
Def: Auto, Range: 100.0 dBFS, BRNR: Pk Peak
BW: 10 Hz, Filter: 100.0 Hz
Digital Reference
dB1: 100.0 mVFS, Freq: 1.000000 kHz
dB2: 100.0 mVFS, VFS: 1.000 V



System Two Cascade Description, Installation, and APWIN Guide



Documentation Issue 2 used with APWIN Version 1.6
March 1999
Audio Precision PN 8211.0078

Copyright © 1999 by Audio Precision, Inc. All rights reserved. No part of this document may be reproduced or transmitted in any form or by any means, electronic or mechanical, including photocopying, recording, or by any information storage and retrieval system, without permission in writing from the publisher.

Audio Precision®, System One®, System One + DSP®, System Two®, Dual Domain®, APWIN®, AUDIO.TST®, FASTTEST®, and Portable One® are registered trademarks of Audio Precision, Inc.



This mark signifies that the product conforms to all applicable requirements of the European Community. A Declaration of Conformance is included with the user information that describes the specifications used to demonstrate conformity.

Published by:

Audio precision®  **Audio Precision, Inc.**
PO Box 2209
Beaverton Oregon 97075-2209

US Toll Free: 1-800-231-7350 Tel: (503) 627-0832 Fax: (503) 231-8906
email: techsupport@audioprecision.com Web: www.audioprecision.com

Printed in the United States of America

Contents

Table of Figures	vi
Safety Information	viii
Safety Symbols.....	ix
Disclaimer	ix
1. Introduction.....	1-1
1.1 Scope of This Manual	1-1
1.2 Related Documentation.....	1-1
1.3 Overview	1-2
1.3.1 General System	1-2
1.3.2 System Two Cascade.....	1-3
1.3.3 Switchers.....	1-6
1.3.4 DCX-127 Multi-Function Module.....	1-7
1.3.5 SIA-2322 Serial Interface Adapter.....	1-8
2. System Two Cascade Specifications.....	2-1
2.1 Analog Signal Outputs	2-1
2.1.1 Analog Signal Generator	2-1
2.1.2 Intermodulation Distortion Related Signals	2-2
2.1.3 Special Purpose Signals	2-3
2.2 D/A Generated Analog Signals	2-4
2.2.1 Common Specifications.....	2-4
2.2.2 "SINE (D/A)" Signal Family	2-4
2.2.3 "IMD (D/A)" Signal Family.....	2-5
2.2.4 OTHER SIGNALS	2-5
2.2.5 Output Characteristics.....	2-7
2.3 Analog Analyzer	2-10
2.3.1 Analog Input Characteristics	2-10
2.3.2 Wideband Amplitude/Noise Function	2-11
2.3.3 IMD Measurements.....	2-14
2.3.4 Wow & Flutter Measurements.....	2-15
2.4 Option Filters	2-16
2.5 DSP Analysis of Analog Signals.....	2-24
2.5.1 High Resolution Converter	2-24
2.5.2 High Bandwidth Converter.....	2-24
2.5.3 FFT Signal Analyzer	2-24
2.5.4 DSP Audio Analyzer	2-26
2.5.5 Quasi-Anechoic Acoustical Tester.....	2-29
2.5.6 Multitone Audio Analyzer.....	2-29

Contents

2.6	Digital Signal Generator	2-30
2.6.1	Digital Output Characteristics	2-30
2.6.2	Digital Signal Generation	2-30
2.7	AES/EBU Interface Generation	2-35
2.7.2	Reference Input Characteristics	2-36
2.7.3	Reference Output Characteristics	2-36
2.8	Digital Analyzer	2-37
2.8.1	Digital Input Characteristics	2-37
2.8.2	Embedded Audio Measurements	2-37
2.8.3	Digital Interface Measurements	2-40
2.8.4	Digital Interface Analyzer	2-41
2.9	Auxiliary Signals	2-44
2.9.1	Generator Signal Monitors	2-44
2.9.2	Generator Auxiliary Signals	2-44
2.9.3	Analyzer Signal Monitors	2-44
2.9.4	Digital Signal Monitors	2-44
2.9.5	Digital Interface Monitors	2-44
2.9.6	Miscellaneous Digital I/O	2-45
2.10	Audio Monitor	2-45
2.11	Primary Power and Fuse Information	2-45
2.12	Environmental	2-45
2.13	Physical Dimensions and Weights	2-45
2.14	Regulatory Compliances	2-46
2.15	Software and Control	2-46
2.15.1	Computer Requirements	2-46
2.15.2	ISA-WIN APIB Card	2-47
2.15.3	PCM-WIN Card	2-47
2.15.4	Cables and Adapters	2-48
3.	Hardware Installation	3-1
3.1	Rack Mounting	3-1
3.1.1	Fixed Rack-Mounting Brackets	3-1
3.1.2	Sliding Rack-Mounting Brackets	3-2
3.1.3	Rackmounting the Switchers, SIA-2322, and DCX-127	3-3
3.2	Primary Power Considerations	3-3
3.2.1	AC Mains Switch Required	3-3
3.2.2	Checking or Changing Power Line Voltage	3-3
3.2.3	Fuse Information	3-5
3.2.4	Changing Fusing Arrangement	3-6
3.2.5	Proper Environment	3-6

- 3.3 Installing ISA-WIN APIB Card 3-7
 - 3.3.1 Address Jumper Settings 3-8
- 3.4 Installing PCM-WIN PCMCIA Interface Card 3-9
- 3.5 Connecting the APIB Interface..... 3-9
- 3.6 Setting Switcher Addresses and Modes 3-10
 - 3.6.1 Switcher Address Settings 3-11
 - 3.6.2 Input, Output, and Patch Point Switcher Mode Switches. 3-12
 - 3.6.3 Unbalanced Switcher Mode Switch..... 3-13
 - 3.6.4 Switcher Circuit Board Jumpers..... 3-14
- 4. Software Installation– Windows 95, 98, and NT..... 4-1**
 - 4.1 Using PCM-WIN card with Windows 95 or NT..... 4-7
- 5. Getting Started with APWIN..... 5-1**
 - 5.1 Starting APWIN 5-1
 - 5.1.1 Automating APWIN Startup..... 5-4
 - 5.2 User Preferences 5-7
 - 5.3 APWIN Help 5-10
 - 5.4 Using Printers with APWIN..... 5-11
 - 5.5 Compatibility with S1.EXE 5-12
 - 5.5.1 Utilizing S1.EXE Test and Procedures..... 5-13
 - 5.5.2 Remote Operation via RS-232 Inteface 5-13
 - 5.5.3 S1.EXE Utility Programs 5-13
 - 5.6 Publishing Graphs..... 5-14
 - 5.7 Technical Support 5-15

Table of Figures

Figure 1-1. SWR-2122 Switchers.....	1-6
Figure 1-2. DCX-127 Multi-Function Module.....	1-7
Figure 1-3. SIA-2322 Serial Interface Adapter.....	1-8
Figure 2-1. Typical total system THD+N versus frequency using analog sinewave at 2 Vrms..	2-7
Figure 2-2. Typical THD+N versus Amplitude at 1 kHz	2-8
Figure 2-3. Typical analog generator residual THD+N spectrum at 1 kHz, 2 Vrms	2-8
Figure 2-4. Typical analog generator residual THD+N spectrum at 20 kHz, 2 Vrms	2-9
Figure 2-5. Typical analog System flatness at 2 V rms signal level	2-9
Figure 2-6. Standard Band-limiting filters included with every System Two.	2-18
Figure 2-7. FIL-AWT ANSI-IEC "A" Weighting Filter	2-18
Figure 2-8. FIL-CCR CCIR-468 / DIN 45404 Noise Weighting Filter	2-19
Figure 2-9. FIL-CIT CCITT P53 Noise Weighting Filter	2-19
Figure 2-10. FIL-CMS C-Message Weighting Filter (ANSI/IEEE 743-1984).....	2-19
Figure 2-11. FIL-CWT "C" Weighting (IEC-179).....	2-20
Figure 2-12. FLP-1K 1 kHz Low Pass 5-pole Butterworth Filter	2-20
Figure 2-13. FLP-20K 20.0 kHz Quasi-elliptic sharp cutoff Low Pass Filter	2-20
Figure 2-14. FLP-50K 50 kHz 3-pole Butterworth Low Pass Filter	2-20
Figure 2-15. FLP-8K 8 kHz 7-pole Butterworth Low Pass Filter	2-21
Figure 2-16. FLP-A20K Apogee "Brick Wall" 20 kHz Low Pass Filter.....	2-21
Figure 2-17. FHP-400 400 Hz 9-pole High Pass Filter	2-21
Figure 2-18. FBP-XXXX Fixed 1/3 Octave Band Pass Filter	2-21
Figure 2-19. FBP-500X High-Q 500 Hz Band Pass Filter (for CD linearity testing)	2-22
Figure 2-20. FIL-RCR 200 Hz to 15 kHz with 19 kHz (FM) notch Receiver Testing Filter.....	2-22
Figure 2-21. FIL-IECR 20 Hz to 15 kHz w/ 15.625 kHz (PAL) notch Receiver Testing Filter.	2-22
Figure 2-22. FIL-D75B 75 μ s with 15.734 kHz (NTSC) notch De-emphasis Filter.....	2-22
Figure 2-23. FIL-D75F 75 μ s with 19 kHz (FM) notch De-emphasis Filter	2-23
Figure 2-24. FIL-D50F 50 μ s with 19 kHz (FM) notch De-emphasis Filter	2-23
Figure 2-25. FIL-D75 75 μ s De-emphasis Filter	2-23
Figure 2-26. FIL-D50 50 μ s De-emphasis Filter	2-23
Figure 2-27. Windows available with FFT function (figure 1 of 2).....	2-25
Figure 2-28. Windows available with FFT function (figure 2 of 2).....	2-26
Figure 2-29. Digital Analyzer F-weighting curve	2-27
Figure 2-30. Digital Domain Band Pass filter response.	2-28
Figure 2-31. Shaped Sine Burst signal (1 kHz, 10 cycles).....	2-32
Figure 2-32. Digital Domain Band Pass filter response	2-42
Figure 2-33. Typical Digital Domain system residual THD+N	2-42
Figure 2-34. Illustration of typical Digital Domain FFT dynamic range.....	2-43
Figure 2-35. CAB-XBR cable kit.....	2-48
Figure 2-36. XLR to BNC wiring	2-49
Figure 2-37. CAB-AES cable set.....	2-49
Figure 2-38. CAB-DIO Cables	2-50
Figure 3-1. Fixed installation rackmounting kit.....	3-1
Figure 3-2. Sliding rack mount installation kit	3-2
Figure 3-3. Changing power line voltage	3-3
Figure 3-4. Voltage selector card positions.....	3-4
Figure 3-5. North American fusing arrangement	3-5
Figure 3-6. European fusing arrangement	3-5
Figure 3-7. Changing fuse types.....	3-6
Figure 3-8. ISA-WIN Interface Card and cable.....	3-7
Figure 3-9. ISA-WIN APIB Card with address jumper selections shown.....	3-8

Table of Figures

Figure 3-10. PCMCIA to APIB interface card and cable.....	3-9
Figure 3-11. APIB connections block diagram (typical).....	3-10
Figure 3-12. Rear panel DIP switch (typical)	3-11
Figure 3-13. Unbalanced switcher address/mode switch.....	3-13
Figure 3-14. Switcher mode jumper positions.....	3-14
Figure 4-1. APWIN installation Setup screen.....	4-2
Figure 4-2. Windows NT Administrator rights warning screen	4-2
Figure 4-3. Setup progression screen	4-2
Figure 4-4. Welcome screen.....	4-3
Figure 4-5. Choose Destination Location for APWIN dialog box	4-3
Figure 4-6. Choose Destination Location for sample tests, procedures, and data files.....	4-4
Figure 4-7. Choose Components to Install dialog box	4-5
Figure 4-8. Select Program Manager Group dialog box	4-6
Figure 4-9. Installing progress screen.....	4-6
Figure 4-10. Setup Complete message window	4-7
Figure 5-1. APWIN directory window.....	5-1
Figure 5-2. Choose Hardware window	5-1
Figure 5-3. Demo Mode warning window	5-2
Figure 5-4. Windows 95 File Open dialog box.....	5-3
Figure 5-5. Procedure tool bar.....	5-3
Figure 5-6. System Two Cascade Example Selection Menu window.....	5-3
Figure 5-7. System Two Sample Test Procedures window	5-4
Figure 5-8. APWIN Properties dialog box	5-5
Figure 5-9. Configuration dialog box, General tab.....	5-7
Figure 5-10. Configuration dialog box, Hardware tab	5-8
Figure 5-11. Configuration dialog box, Configure Files tab	5-8
Figure 5-12. Configuration dialog box, Log tab	5-9
Figure 5-13. Configuration dialog box, Graph tab	5-9
Figure 5-14. Windows 95 Windows Help screen.....	5-11
Figure 5-15. Printer Setup dialog box	5-12
Figure 5-16. About APWIN window	5-15

Safety Information

Do NOT service or repair this product unless properly qualified. Only a qualified technician or an authorized Audio Precision distributor should perform servicing.

Do NOT defeat the safety ground connection. This product is designed to operate only from a 50/60 Hz AC power source (250 Vrms maximum) with an approved three-conductor power cord and safety grounding. Loss of the protective grounding connection can result in electrical shock hazard from the accessible conductive surfaces of this product.

For continued fire hazard protection, fuses should be replaced ONLY with the exact value and type as indicated on the rear panel and Section 3.2.3 of this document. The AC voltage selector also must be set to the same voltage as the nominal power source voltage (100, 120, 230, or 240V rms) with the appropriate fuses installed.

The International Electrotechnical Commission (IEC 1010-1) requires that measuring circuit terminals used for voltage or current measurement be marked to indicate their *Installation Category*. The Installation Category is defined by IEC 664 and is based on the amplitude of transient or impulse voltage that can be expected from the AC power distribution network. This product is classified as INSTALLATION CATEGORY II, abbreviated “**CAT II**” on instrument front panels.

Do NOT substitute parts or make any modifications without the written approval of Audio Precision. Doing so may create safety hazards.

This product contains a lithium battery. Dispose only in accordance with all applicable regulations.

This product is for indoor use – pollution degree 2.

Safety Symbols



WARNING! – This symbol alerts you to a potentially hazardous condition, such as the presence of dangerous voltage that could pose a risk of electrical shock. Refer to the accompanying Warning Label or Tag, and exercise extreme caution.



ATTENTION! – This symbol alerts you to important operating considerations or a potential operating condition that could damage equipment. Refer to the User's Manual or Operator's Manual for precautionary instructions.



FUNCTIONAL EARTH TERMINAL – This symbol marks a terminal that is electrically connected to a reference point of a measuring circuit or output and is intended to be earthed for any functional purpose other than safety.

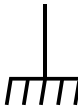

PROTECTIVE EARTH TERMINAL – This symbol marks a terminal that is bonded to conductive parts of the instrument. Confirm that this terminal is connected to an external protective earthing system.

Disclaimer

Audio Precision cautions against using their products in a manner not specified by the manufacturer. To do otherwise may void any warranties, damage equipment, or pose a safety risk to personnel.

1. Introduction

1.1 Scope of This Manual

This guide serves several purposes:

- It will help you install the hardware and software for APWIN, Audio Precision's user interface and software package for System Two Cascade.
- It describes several basic hardware considerations for installing the components, such as power line voltage settings, fuse information, APIB Interface Cable connections, and jumper and DIP switch settings.
- It contains full specifications for the System Two, including its options and ancillary components (switchers, etc).
- It contains some fundamental APWIN assistance, such as starting, setting user preferences, APWIN help files, compatibility issues, and troubleshooting.

Although intended specifically for APWIN Version 1.6, many parts of this guide are applicable to earlier versions. Notice, however, that beginning with APWIN Version 1.6, operation is no longer supported on operating systems prior to Windows 95 or Windows NT 4.0.

Section 1.2 gives a list of other System Two Cascade documents and a brief description of the contents of each.

1.2 Related Documentation

- **APWIN System Two Cascade User's Manual** – contains a comprehensive description of the full capabilities of APWIN.
- **APWIN Simplified** – designed to lead you through your first operating session with APWIN and System Two.
- **APWIN Basic User's Guide and Language Reference** – Provides a comprehensive introduction to APWIN Basic, and includes detailed descriptions and syntax for generic commands common to all platforms.
- **APWIN Basic Extensions Reference for System Two Cascade** –detailed descriptions and syntax for commands

specific to System Two Cascade. Includes a list of all APWIN system panels, an alphabetical listing of all APBASIC extensions, and technical reference information for the command extensions.

- **SIA-2322 Serial Interface Adapter User's Manual** – details the capabilities and operation of the SIA-2322. This manual comes with the SIA-2322, a highly specialized optional accessory.
- **Audio Measurement Handbook** – intended as a practical, hands-on assistance for workers in all phases of the audio field. Describes general measurement techniques and includes a glossary of specific audio terminology and test definitions.

1.3 Overview

1.3.1 General System

System Two Cascade is a personal computer-based audio test set with broad, high-performance capabilities for analog, digital, and mixed-signal devices. System Two Cascade includes both signal generation and analysis capability for audio stimulus-response testing. Virtually all common and many specialized tests are performed on analog domain and digital domain signals and on the digital interface signal (pulse train) itself.

The versatility of the System Two Cascade can be extended through major options and accessories. The SWR-2122-series of Audio Switchers are available in input, output, and insertion (patch point) versions. The DCX-127 adds dc measurement and digital generation capabilities. The SIA-2322 Serial Interface Adapter converts the System Two's parallel input and outputs to a wide variety of serial digital interface formats. These accessories are described in greater detail in the following subsections.

The System Two Cascade and its accessories are controlled by APWIN, Audio Precision's user interface and software package, which must be installed in the user's personal computer (the computer is not included).

Specifications for the System Two Cascade and its accessories are found in Section 2.

1.3.2 System Two Cascade

System Two Cascade audio test equipment provides stimulus and measurement capability. System Two Cascade extends the System Two family of product configurations, as listed below. Note that this guide applies only to System Two Cascade, running under APWIN version 1.6. For earlier System Two products or for earlier versions of APWIN, refer to *System Two Description, Installation, and APWIN Guide*, Audio Precision PN 8211.0026.

- The 2422-Series is based on the advanced Cascade platform. It provides analog stimulus and measurement capability, using analog circuits for signal generation, filtering, and measurement. It also has a dual-channel DSP analyzer and dual-channel DAC signal source. Its enhanced capability includes digital signal generation, high-resolution spectrum analysis via FFT, waveform capture and display, and fast multitone testing.
- The 2522-Series is the Dual Domain product in the Cascade platform. It includes the capabilities of the 2422 series plus digital audio inputs and outputs in AES/EBU, SPDIF/EIAJ, optical, parallel, general-purpose serial formats and complete serial interface analysis per AES3. Thus, it provides stimulus and measurement in any combination of digital and analog domains.
- The 2500-Series has the same digital capabilities of 2522 series above, but no analog capabilities.

All Cascade models feature sample rates up to 96 kHz. The models described above have a suffix “A” or “G.” The “A” denotes the instrument is APIB-controlled with APWIN software; the “G” denotes the instrument is GPIB (IEEE-488)-controlled. This guide covers the APIB interface with APWIN control; other manuals cover GPIB installation and control.

System Two Cascade is normally supplied with an ISA-bus interface card for installation in the user’s PC. Alternatively, a type II PCMCIA interface card may be furnished for use in a notebook computer. An option replaces this card with a PCM-WIN-SUB2 Type II card. Each of these cards comes with the appropriate APIB (Audio Precision Interface Bus) cable to interconnect the computer with the System Two Cascade.

This version of APWIN requires one of these cards, and will not function with earlier System One PCI-1, PCI-2, or PCI-3 interface cards or PCM-DOS PCMCIA interface cards. Also, APWIN Version 1.6 runs

under Windows 95 and higher, and is not compatible with Windows 3.11.

These analog options may be installed in your System Two Cascade:

- S2-IMD Adds the IMD (InterModulation Distortion) generator and IMD analyzer.
- S2-W&F Adds the wow and flutter analyzer.
- S2-BUR Adds the tone burst, square wave, and noise generator.
- S2-EURZ Changes the generator output selections to 40/200/600 ohms, prevalent in Europe.

Additionally, your System Two Cascade may include up to seven of these optional hardware filters, or may include custom filters:

- FIL-AWT A-weighting filter
- FIL-CWT C-weighting filter
- FIL-CCR CCR 468-3 weighting filter
- FIL-CIT CCITT P.53 weighting filter
- FIL-CMS C-message weighting filter
- FIL-D50F 50 μ s de-emphasis filter + 19.0 kHz notch filter
- FIL-D75 Precision 75 μ s de-emphasis filter
- FIL-D75B 75 μ s de-emphasis + 15.734 kHz notch filter
- FIL-D75F 75 μ s de-emphasis + 19.0 kHz notch filter
- FBR-15625 15.625 kHz band reject (notch) filter
- FBR-15734 15.734 kHz band reject (notch) filter
- FBR-19000 19 kHz band reject (notch) filter
- FIL-RCR 200 Hz – 15 kHz bandpass with 19 kHz notch filter
- FLP-xxx Fixed low pass (precision band limiting filter; frequency specified as 10 kHz, 15 kHz, 19 kHz, 20 kHz, or 22 kHz. Sharp roll-off > 50 dB at $2f_0$)
- FBP-xxxxx Fixed 1/3-octave bandpass filter; frequency specified from 100 Hz to 25000 Hz
- FIL-USR User-buildable filter circuit board and instructions
- FLP-A20k 20 kHz “brick wall” filter
- FIL2-EXT External filter kit for System Two

A rear-panel configuration label on the System Two Cascade identifies the model number, the options and filters installed, and the warranty expiration date (domestic) or date of manufacture (export).

1.3.3 Switchers



Figure 1-1. SWR-2122 Switchers

The four versions of switchers are described below. Each features 12 x 2 architecture with provisions for cascading up to 16 units, allowing up to 192 channels to be accessed. Switching is computer-controlled via the same APIB as the System Two Cascade. See Section 3.6 for further information.

- **SWR-2122M** Output Switcher. Routes either of the two generator output channels (A & B) to any of 12 channels. Uses male XLR connectors for balanced signals. Complement mode allows all but one channel to be driven while measuring the undriven channel for worst-case crosstalk on multichannel devices.
- **SWR-2122F** Input Switcher. Routes either of the two analyzer input channels (A & B) from any of 12 channels. Uses female XLR connectors for balanced signals.
- **SWR-2122U** Unbalanced Switcher. Can be used as either an input or output switcher. Uses floating BNC connectors for unbalanced signals to prevent ground loops.
- **SWR-2122P** Patch-Point Switcher. 12-point configuration allows a signal path to be interrupted and a test generator inserted while a measuring analyzer can

access the output of a previous device. Path continuity is maintained in the default (non-accessed) mode. Each of the 12 insertion points has a 5-pin XLR connector to allow balanced interface to the previous and next device.

1.3.4 DCX-127 Multi-Function Module



Figure 1-2. DCX-127 Multi-Function Module

The DCX-127 Multi-Function Module contains an autoranging 4-1/2 digit dc voltmeter-ohmmeter, two 20-bit programmable dc voltage sources, 21 bits of digital I/O, and three 8-bit programmable auxiliary output ports for device control or status indicators. Typical applications include A/D and D/A converter testing, VCA gain control linearity, VCA distortion, amplifier dc offset and power supply checks, power amplifier load switching control, loudspeaker voice coil resistance measurements, temperature measurements, and test fixture control.

The meter features 200 mV – 500 V and 200 Ω – 2 M Ω ranges, fully floating and guarded for accurate measurements in the presence of large common mode voltages. Resistance measurements can be made using either 4-wire or 2-wire techniques. Readings can be offset and scaled by the software.

The two independently programmable dc sources have a ± 10.5 V bipolar range with 20 μ V resolution and monotonicity to 40 μ V (19 bits). The software can sweep either dc source.

The DCX-127 also contains a simplified 8-bit program control interface that can be defined to execute any pre-defined keystroke sequence. This can be used to run different software procedures based upon switch closures.

1.3.5 SIA-2322 Serial Interface Adapter



Figure 1-3. SIA-2322 Serial Interface Adapter

The SIA-2322 Serial Interface Adapter provides a means of interfacing the System Two Cascade system to a variety of data acquisition, reconstruction, and communication hardware that utilize a serial bus for data exchange. This greatly increases the system's flexibility in interfacing to serial systems for a wide range of tests and measurements.

The SIA-2322 consists of a parallel-to-serial transmitter and an independent serial-to-parallel receiver. A flexible design allows the SIA to address many serial interface requirements.

2. System Two Cascade Specifications

2.1 Analog Signal Outputs

All System Two Cascade configurations, except the SYS-2500, contain an analog signal generator consisting of an ultra-low distortion analog sine wave generator and two independent transformer coupled output stages that can be driven from both the analog sources and optional hardware signal generators. Option “BUR” adds analog generated sine burst, square wave, and noise signals. Option “IMD” adds analog-generated IMD test signals. SYS-2422 and SYS-2522 configurations also contain dual channel D/A-based signal generation capability. Unless otherwise noted, all specifications are valid for outputs $\geq 150 \mu\text{V}_{\text{rms}}$ [420 μV_{pp}].

2.1.1 Analog Signal Generator

2.1.1.1 Low Distortion Sine Wave

Frequency Range	10 Hz to 204 kHz
Frequency Accuracy	
High-accuracy mode	$\pm 0.03\%$
Fast mode	$\pm 0.5\%$
Frequency Resolution	
High-accuracy mode	0.005%
Fast mode	0.025 Hz, 10 Hz-204.75 Hz; 0.25 Hz, 205 Hz-2.0475 kHz; 2.5 Hz, 2.05 kHz-20.475 kHz; 25 Hz, 20.5 kHz-204 kHz
Amplitude Range ¹	
Balanced	<10 μV to 26.66 Vrms [+30.7 dBu]
Unbalanced	<10 μV to 13.33 Vrms [+24.7 dBu]
Amplitude Accuracy	$\pm 0.7\%$ [± 0.06 dB] at 1 kHz
Amplitude Resolution	
$V_{\text{out}} \geq 150 \mu\text{V}_{\text{rms}}$	0.003 dB
$V_{\text{out}} < 150 \mu\text{V}_{\text{rms}}$	0.05 μV_{rms}
Flatness (1 kHz ref)	
10 Hz-20 kHz	± 0.008 dB (typically <0.003 dB)
20 kHz-50 kHz	± 0.03 dB
50 kHz-120 kHz	± 0.10 dB
120 kHz-200 kHz	+0.2/-0.3 dB

¹ 20 Hz-50 kHz only. Decrease maximum available output by a factor of 2 (-6.02 dB) for the full 10 Hz-204 kHz range.

Residual Distortion ² 20 Hz – 20 kHz at 1 kHz	typically <0.0001% [-120 dBc]; typically <0.00003% [-130 dBc]
Residual THD+N ³ 20 Hz-20 kHz	≤(0.0004% + 1 μV), 22 kHz BW [-108 dB] ≤(0.0006% + 2 μV), 80 kHz BW [-104 dB] ≤(0.0015% + 6 μV), 500 kHz BW [-96.5 dB]
10 Hz-100 kHz	≤(0.0040% + 6 μV), 500 kHz BW [-88 dB]

2.1.2 Intermodulation Distortion Related Signals

with option "IMD"

2.1.2.1 SMPTE (or DIN) Test Signals

LF Tone	40, 50, 60, 70, 100, 125, 250, or 500 Hz; all ±1.5%
HF Tone Range	2 kHz-200 kHz
Mix Ratio	4:1 or 1:1 (LF:HF)
Amplitude Range ⁴ Balanced	30 μVpp to 75.4 Vpp
Unbalanced	30 μVpp to 37.7 Vpp
Amplitude Accuracy	±2.0% [±0.17 dB]
Residual IMD ⁵	0.0015% [-96.5 dB], 60+7 kHz or 250+8 kHz

2.1.2.2 CCIF and DFD Test Signals

Difference Frequency	80, 100, 120, 140, 200, 250, 500 or 1 kHz; all ±1.5%
Center Frequency	4.5 kHz-200 kHz
Amplitude Range ⁴ Balanced	30 μVpp to 75.4 Vpp
Unbalanced	30 μVpp to 37.7 Vpp
Amplitude Accuracy	±3.0% [±0.26 dB]
CCIF Residual IMD ⁵	≤0.0004% [-108 dB], 14 kHz+15 kHz (odd order & spurious typ <0.05%)
DFD Residual IMD ⁵	≤0.0002% [-114 dB], 14 kHz+15 kHz (odd order & spurious typ <0.025%)

² Relative amplitude of any individual harmonic ≤80 kHz measured with a passive notch filter and FFT analyzer. Not valid for outputs above 12 Vrms balanced, or 6 Vrms unbalanced.

³ Measured with System Two analog analyzer (system specification). Derate 20-25 Hz THD to 0.002% for outputs >20 Vrms balanced, or >10 Vrms unbalanced.

⁴ Calibration with other amplitude units is based upon an equivalent sinewave having the same Vpp amplitude.

⁵ Measured with System Two analog analyzer (system specification).

2.1.2.3 DIM (or TIM) Test Signals

Squarewave Frequency	3.15 kHz (DIM-30 and DIM-100); 2.96 kHz (DIM-B); both $\pm 1\%$
Sinewave Frequency	15 kHz (DIM-30 and DIM-100); 14 kHz (DIM-B)
Amplitude Range ⁴	
Balanced	30 μ Vpp to 75.4 Vpp
Unbalanced	30 μ Vpp to 37.7 Vpp
Amplitude Accuracy	$\pm 2.0\%$ [± 0.17 dB]
Residual IMD ⁵	$\leq 0.0020\%$ [-94 dB]

2.1.3 Special Purpose Signals

with option "BUR"

2.1.3.1 Sine Burst

Frequency Range	20 Hz-100 kHz
Frequency Accuracy	Same as Sinewave
ON Amplitude Range	Bal 30 μ Vpp to 37.7 Vpp Unbal 30 μ Vpp to 18.8 Vpp
Accuracy, Flatness	Same as Sinewave
OFF Ratio Range	0 dB to -80 dB
OFF Ratio Accuracy	± 0.3 dB, 0 to -60 dB
ON Duration	1-65535 cycles, or externally gated
Interval Range	2-65536 cycles

2.1.3.2 Square Wave

Frequency Range	20 Hz-20 kHz
Frequency Accuracy	Same as Sinewave
Amplitude Range ⁴	
Balanced	30 μ Vpp to 37.7 Vpp
Unbalanced	30 μ Vpp to 18.8 Vpp
Amplitude Accuracy	$\pm 2.0\%$ [± 0.17 dB] at 400 Hz
Rise/fall time	Typically 2.0 μ s

2.1.3.3 Noise Signals

White Noise	Bandwidth limited 10 Hz – 23 kHz
Pink Noise	Bandwidth limited 10 Hz – 200 kHz
Bandpass Noise	Approximately 1/3-octave (2-pole) filtered pink noise, continuously tunable from 20 Hz-100 kHz
Generator	True random or Pseudo-random
Pseudo-Random Repeat Time	Typically 262 ms (synchronized to the analyzer 4/s reading rate)
Amplitude Range ⁴	(Approximate calibration only)
Balanced	30 μ Vpp to 37.7 Vpp
Unbalanced	30 μ Vpp to 18.8 Vpp

2.2 D/A Generated Analog Signals

Available only in models SYS-2422 and SYS-2522. All D/A generated signals (except Arbitrary Waveform) may be selected simultaneously and independently with the concurrently available digital domain output signals. Unless otherwise stated, amplitude range, accuracy, and resolution are the same as for the analog sinewave signal.

2.2.1 Common Specifications

D/A Resolution	24-bit sigma-delta, stereo
Sample Rate (SR)	
Sine, IMD signals	fixed 65.536ks/s or 131.072ks/s
Other signals	7.2ks/s to 108.0ks/s variable; or fixed 65.536ks/s or 131.072ks/s
Frequency Accuracy	$\pm 0.0002\%$ [2 PPM] internal reference, lockable to external reference

2.2.2 "SINE (D/A)" Signal Family

The Sine family includes "Normal", "Var Phase", "Stereo", "Dual", "Shaped Burst", and "EQ Sine". Normal and EQ Sine modes produce a monaural signal with the same frequency in both channels and provide the lowest residual THD+N performance. EQ Sine differs from Normal only by varying the amplitude in accordance with a selected EQ file. Var Phase mode produces the same sinewave in both channels but with settable phase offset. Stereo mode provides sinewaves of independently settable frequency in each channel (phase is random if both frequencies are set equal). Dual mode produces a monaural test signal containing a mixture of two sinewaves of independently settable frequency and amplitude ratio. Shaped Burst produces a monaural sine burst signal with a raised cosine amplitude envelope (see Figure 2-31).

Frequency Ranges	10 Hz to 30 kHz (65.536 ks/s), or 10 Hz to 60 kHz (131.072 ks/s)
Frequency Resolution	Sample Rate $\div 2^{23}$ (typ 0.0078 Hz in the 30kHz range)
Flatness (1 kHz ref)	
20 Hz-20 kHz	± 0.01 dB
10 Hz-30 kHz	± 0.03 dB
30 kHz-50 kHz	± 0.10 dB (typ -0.5 dB at 60 kHz)
THD+N ⁶ (20 Hz - 20 kHz)	
30 kHz range	0.0007% [-103 dB];
60 kHz range	0.0010% [-100 dB]
Variable Phase Range	-180.0 to +179.9 deg
Dual-Sine Ratio Range	0 dB to -100 dB, usable to -138 dB
Shaped Burst Interval	2-65536 cycles
Shaped Burst On Time	1 to number of interval cycles minus 1

⁶

Measured with System Two analog analyzer, BW = 22 kHz.

2.2.3 “IMD (D/A)” Signal Family

2.2.3.1 SMPTE/DIN Test Signal

LF Tone	40 Hz to 500 Hz (continuously settable)
HF Tone	2.00 kHz to >30kHz
Mix Ratio	4:1 or 1:1 (LF:HF)
Residual IMD ⁷	≤0.0010% [-100 dB], 60/7kHz or 250/8kHz

2.2.3.2 CCIF/DFD Test Signal

Difference Frequency	80 Hz to 2 kHz
Center Frequency	4.50 kHz to >25 kHz
Residual CCIF IMD ²	≤0.0004% [-108 dB], 14kHz/15kHz pair
Residual DFD IMD ²	≤0.0002% [-114 dB], 14kHz/15kHz pair
Odd order and spurious	typ <0.0004% [-108 dB]

2.2.3.3 DIM Test Signal

Squarewave Frequency	3.15 kHz for DIM30 and DIM100; 2.96 kHz for DIMB
Sinewave Frequency	15.00 kHz for DIM30 and DIM100, 14.00 kHz for DIMB
Residual IMD ⁷	≤0.0020% [-94 dB]

2.2.4 OTHER SIGNALS

2.2.4.1 Arbitrary Waveform (and Multitone)

Signal	determined by the associated file specified in the panel drop-down box.
Number of Tones	1-8191
Length	256-16384 points per channel, user specified waveform. Utility is provided to prepare a time record file from user specified frequency, amplitude, and phase data.
Frequency Range	20 Hz to 47% of sample rate
Frequency Resolution	Sample Rate ÷ 2 ¹⁴ (typ 2.92 Hz at 48 ks/s)

2.2.4.2 Maximum Length Sequence (MLS)

Sequences	4 pink, 4 white
Sequence Length	“32k” (32767) or “128k” (131071)
Frequency Range	10 Hz TO 47% of sample rate

⁷

Measured with System Two analog analyzer.

2.2.4.3 Special Signals

Polarity	Asymmetric waveform for polarity testing. 20 Hz to 15 kHz @30 kHz bandwidth 20 Hz to 30 kHz @ 60 kHz bandwidth
Pass Thru	Accepts signal at rear panel Reference Input with sample rate from 27 kHz to 54 kHz.

2.2.4.4 Squarewave

Frequency Range	20 Hz to 15.1 kHz
Risetime	Typically 2.0 μ s

2.2.4.5 Noise Signal

True random white	
-------------------	--

2.2.5 Output Characteristics

Source Configuration	Selectable balanced, unbalanced, or CMTST (common mode test)
Source Impedances	
Balanced or CMTST	40 Ω (±1 Ω), 150 Ω (±1 Ω) ⁸ , or 600 Ω (±3 Ω)
Unbalanced	20 Ω (±1 Ω) or 600 Ω (±3 Ω)
Max Floating Voltage	42 V pk
Output Current Limit	Typically >80 mA peak
Max Output Power	
Balanced	+30.1 dBm into 600 Ω (Rs = 40 Ω)
Unbalanced	+24.4 dBm into 600 Ω (Rs = 20 Ω)
Output Related Crosstalk	
10 Hz-20 kHz	≤-120 dB or 5 μV, whichever is greater
20 kHz-100 kHz	≤-106 dB or 10 μV, whichever is greater

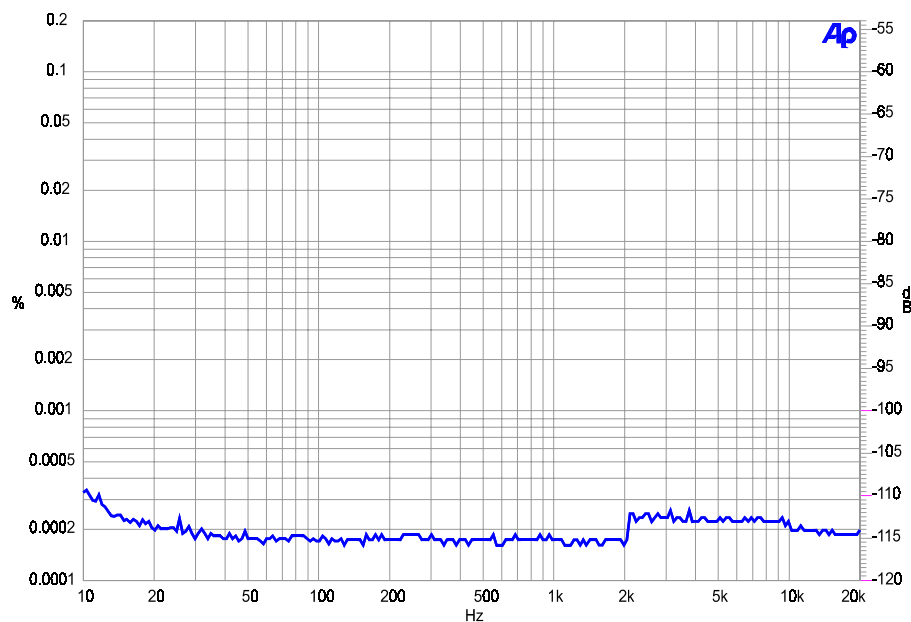

Figure 2-1. Typical total system THD+N versus frequency using analog sinewave at 2 Vrms

⁸
200 Ω with option "EURZ"

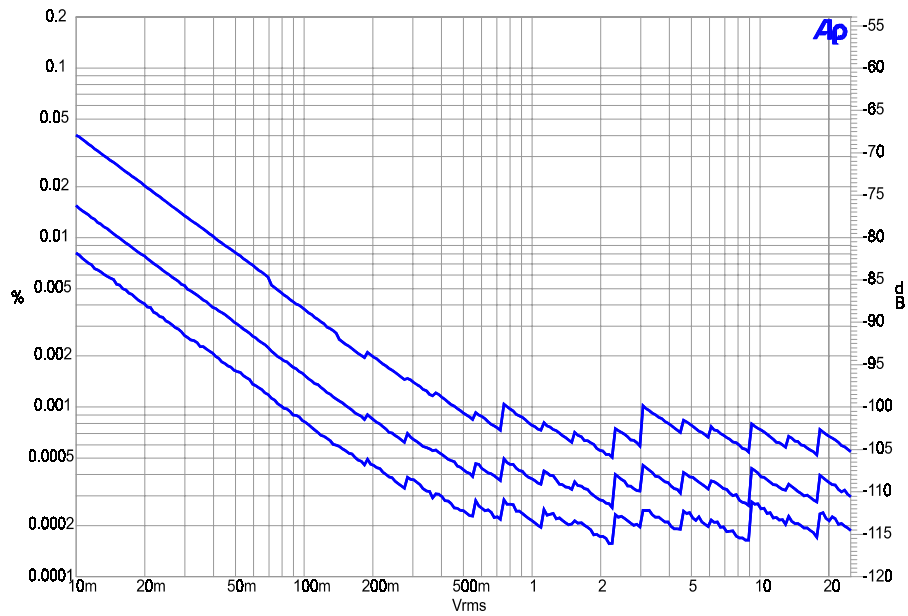

Figure 2-2. Typical THD+N versus Amplitude at 1 kHz for three different analog analyzer measurement bandwidths. Lower curve is with 22 kHz bandwidth limiting. Middle curve is with 80 kHz. Upper curve is with 500 kHz.

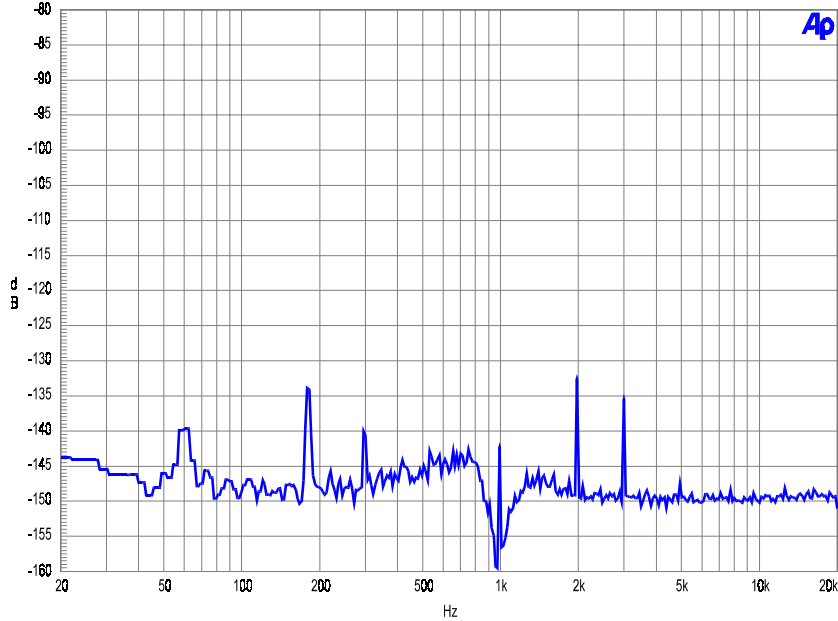

Figure 2-3. Typical analog generator residual THD+N spectrum at 1 kHz, 2 Vrms (16384 point FFT of notch filter output, $F_s = 48$ kHz, 16 averages)

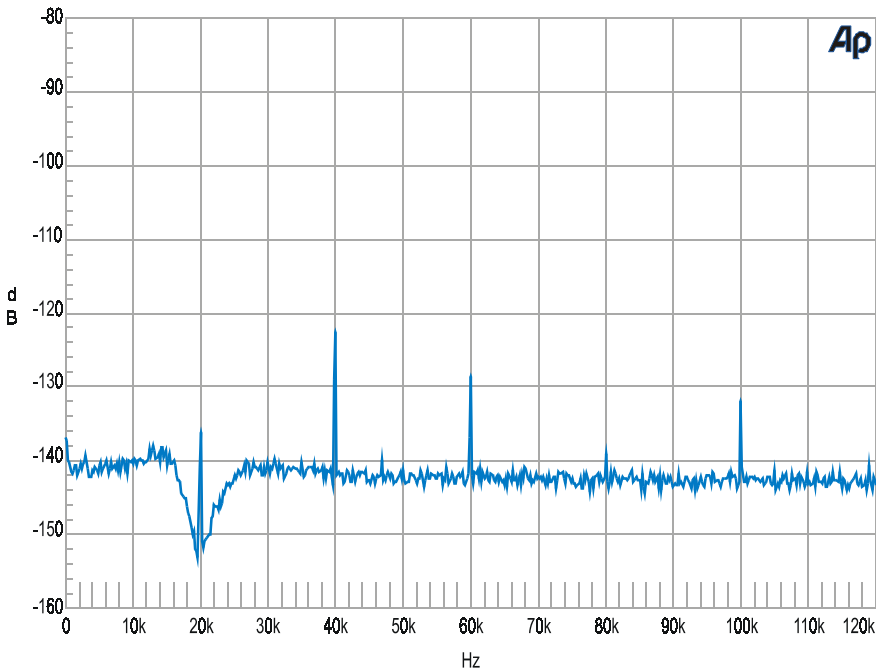

Figure 2-4. Typical analog generator residual THD+N spectrum at 20 kHz, 2 Vrms (16384 point FFT of notch filter output, $F_s = 262$ kHz, 16 averages)

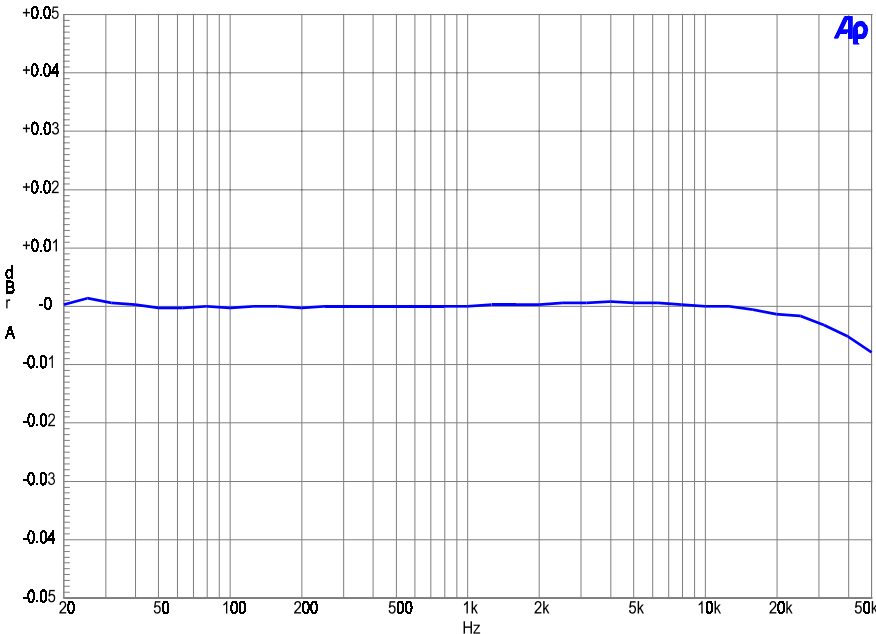

Figure 2-5. Typical analog System flatness at 2 V rms signal level

2.3 Analog Analyzer

All System Two Cascade configurations, except SYS-2500, contain an analog analyzer consisting of an input module with two independent auto-ranging input stages, each having its own level (rms) and frequency meters; a phase meter connected between the channels; plus a single channel multi-function analyzer module providing additional signal processing and gain stages.

SYS-2422 and SYS-2522 configurations also include dual channel A/D converters for FFT and other special forms of analysis on the analog input and analyzer output signals. Unless otherwise noted, all specifications assume dc coupling and rms detection.

Standard analyzer functions include amplitude and noise (both wideband and selective), THD+N, and crosstalk. Option “IMD” adds intermodulation distortion (IMD) measurement capability. Option “W&F” adds wow and flutter measurement capability.

2.3.1 Analog Input Characteristics

Input Ranges	40 mV to 160 V in 6.02 dB steps
Maximum Rated Input	230 Vpk, 160 V rms (dc to 20 kHz); overload protected in all ranges
Input Impedance	
Balanced (each side)	Nominally 100 k Ω // 185 pF (typ)
Unbalanced	Nominally 100 k Ω // 185 pF (typ)
Terminations	Selectable 600 Ω or 300 Ω , $\pm 1\%$; 1 Watt [+30 dBm] maximum power
CMRR ⁹	
40 mV-2.5 V ranges	≥ 80 dB, 10 Hz-20 kHz
5 V and 10 V ranges	≥ 65 dB, 10 Hz-20 kHz
20 V-160 V ranges	≥ 50 dB, 10 Hz-1 kHz
Input Related Crosstalk	
10 Hz-20 kHz	≤ -140 dB or 1 μ V, whichever is greater
20 kHz-100 kHz	≤ -126 dB or 2.5 μ V, whichever is greater

⁹

Not valid below 50 Hz with ac coupling.

2.3.1.1 Level Meter Related

(both channels)

Measurement Range	5 mV-160 V for specified accuracy and flatness, usable to <100 μ V
Resolution (full scale) ¹⁰	
4/s	1/40,000 [0.00022 dB]
8/s	1/40,000 [0.00022 dB]
16/s	1/20,000 [0.00043 dB]
32/s	1/10,000 [0.00087 dB]
64/s	1/5,000 [0.0017 dB]
128/s	1/2,500 [0.0035 dB]
Accuracy (1 kHz)	$\pm 0.5\%$ [± 0.05 dB]
Flatness (1 kHz ref) ¹¹	
20 Hz-20 kHz	± 0.008 dB (typically <0.003 dB)
15 Hz-50 kHz	± 0.03 dB
10 Hz-120 kHz	± 0.10 dB
120 kHz-200 kHz	+0.2/-0.3 dB (typically <-0.5 dB at 500 kHz)

2.3.1.2 Frequency Meter Related

(both channels)

Measurement Range	10 Hz-500 kHz
Accuracy	$\pm 0.0006\%$ [± 6 PPM]
Resolution	6 digits + 0.000244 Hz
Minimum Input	5 mV

2.3.1.3 Phase Measurement Related

Measurement Ranges	± 180 , -90/+270, or 0/+360 deg
Accuracy ¹²	
10 Hz-5 kHz	± 0.5 deg
5 kHz-20 kHz	± 1 deg
20 kHz-50 kHz	± 2 deg
Resolution	0.1 deg
Minimum Input	5 mV, both inputs

2.3.2 Wideband Amplitude/Noise Function

Measurement Range	<1 μ V – 160 V rms
Accuracy (1 kHz)	$\pm 1.0\%$ [± 0.09 dB]

¹⁰

Resolution within a given range is equal to its full scale value multiplied by the fraction indicated for the selected reading rate. (Example: 40 mV input range reading resolution = 4 μ V, using the 32/s reading rate). Numerical displays using a dB unit are rounded to the nearest 0.001 dB.

¹¹

Derate flatness above 5 kHz by an additional ± 0.02 dB in the 20 V, 40 V, 80 V, and 160 V input ranges.

¹²

Both analyzer input channels must have same coupling (ac or dc) selection. Accuracy is valid for any input signal amplitude ratio up to ± 30 dB.

Flatness (1 kHz ref) ¹³	
20 Hz-20 kHz	±0.02 dB
15 Hz-50 kHz	±0.05 dB
50 kHz-120 kHz	±0.15 dB
120 kHz-200 kHz	+0.2 dB/-0.3 dB (typically < -3 dB at 500 kHz)
Bandwidth Limiting Filters	
LF -3 dB	<10 Hz, 22 Hz per CCIR Rec 468, 100 Hz ±5% (3-pole), or 400 Hz ±5% (3-pole)
HF -3 dB	22 kHz per CCIR Rec 468, 30 kHz ±5% (3-pole), 80 kHz ±5% (3-pole), or >500 kHz
Optional Filters	up to 7 (see Section 2.4)
Detection	RMS ($\tau = 25$ ms or 50 ms), AVG, QPk per CCIR Rec 468, Pk (pseudo-peak), or S-Pk (0.7071 x Pk reading)
Residual Noise	
22 Hz-22 kHz BW	≤1.0 μ V [-118 dBu]
80 kHz BW	≤2.0 μ V [-112 dBu]
500 kHz BW	≤6.0 μ V [-102 dBu]
A-weighted	≤0.5 μ V [-124 dBu]
CCIR-QPk	≤2.5 μ V [-110 dBu]

2.3.2.1 Bandpass Amplitude Function

Tuning Range (f_0)	10 Hz to 200 kHz
Tuning Accuracy	±2%
Bandpass Response	1/3-octave class II (4-pole); <-32 dB at 0.5 f_0 and 2.0 f_0
Accuracy (at f_0)	±0.3 dB, 20 Hz-120 kHz
Residual Noise	
10 Hz-5 kHz	≤0.25 μ V [-130 dBu]
5 kHz-20 kHz	≤0.5 μ V [-124 dBu]
20 kHz-200 kHz	≤1.5 μ V [-114 dBu]

2.3.2.2 Bandreject Amplitude Function

Tuning Range (f_0)	10 Hz to 200 kHz
Tuning Accuracy	±2%
Bandreject Response	typically: -3 dB at 0.73 f_0 & 1.37 f_0 -20 dB at f_0 ±10% -40 dB at f_0 ±2.5%
Accuracy	±0.3 dB, 20 Hz-120 kHz (excluding 0.5 f_0 to 2.0 f_0)
Residual Noise	same as Amplitude Function

¹³

Derate flatness above 5 kHz by an additional ±0.02 dB in the 20 V, 40 V, 80 V, and 160 V input ranges.

2.3.2.3 THD + N Function

Fundamental Range	10 Hz to 200 kHz
Measurement Range	0 – 100%
Accuracy	±0.3 dB, 20 Hz – 120 kHz harmonics
Measurement Bandwidth	
LF -3 dB	<10, 22, 100, or 400 Hz
HF -3 dB	22k, 30k, 80k, or >500 kHz; option filters are also functional
Residual THD+N ¹⁴	
20 Hz-20 kHz	≤(0.0004% + 1.0 μV), 22 kHz BW [-108 dB] ≤(0.0006% + 2.0 μV), 80 kHz BW [-104 dB] ≤(0.0015% + 6.0 μV), 500 kHz BW [-96.5 dB]
10 Hz-100 kHz	≤(0.0040% + 6.0 μV), 500 kHz BW [-88 dB]
Minimum Input	5 mV for specified accuracy, usable to <100 μV with fixed notch tuning
Notch Tuning Modes	Counter Tuned, Sweep Track, Agen-Track (analog generator), Dgen-Track (digital generator), or Fixed (set by direct entry)
Notch Tracking Range	±2.5% from fixed setting

2.3.2.4 Crosstalk Function

Frequency Range	10 Hz to 200 kHz
Accuracy ¹⁵	±0.4 dB, 20 Hz-120 kHz
Residual Crosstalk ¹⁵	
10 Hz-20 kHz	≤-140 dB or 1 μV
20 kHz-100 kHz	≤-126 dB or 2.5 μV

¹⁴

System specification including contribution from analog generator. Generator residual THD may limit system performance below 25 Hz if output is >20.0 Vrms balanced, or 10.0 Vrms unbalanced.

¹⁵

Uses the 1/3-octave bandpass filter to enhance the measured range in the presence of wideband noise. Alternate (interfering) channel input must be ≥ 5 mV.

2.3.3 IMD Measurements

with option "IMD"

Option "IMD" adds the capability to measure intermodulation distortion (IMD) using three of the most popular techniques. The demodulated IMD signal can also be selected for FFT analysis in SYS-2422 and SYS-2522 configurations.

2.3.3.1 SMPTE (DIN) IMD Function

Test Signal Compatibility	Any combination of 40 – 250 Hz (LF) and 2 kHz – 100 kHz (HF) tones, mixed in any ratio from 0:1 to 8:1 (LF:HF)
IMD Measured	Amplitude modulation products of the HF tone. -3 dB measurement bandwidth is typically 20 Hz – 750 Hz
Measurement Range	0-20%
Accuracy	±0.5 dB
Residual IMD ¹⁶	≤0.0015%, 60 + 7 kHz or 250 + 8 kHz

2.3.3.2 CCIF and DFD IMD Functions

Test Signal Compatibility	Any combination of equal amplitude tones from 4 kHz – 100 kHz spaced 80 Hz – 1 kHz (difference frequency)
IMD Measured CCIF function	2 nd order difference frequency product relative to the amplitude of either test tone
DFD function	u_2 (2 nd order difference frequency product) per IEC 268-3 (1986)
Measurement Range	0 – 20%
Accuracy	±0.5 dB
Residual IMD	CCIF ≤0.0004%, 14 kHz + 15 kHz [-108 dB], DFD ≤ 0.0002%, 14 kHz + 15 kHz [-114 dB]

2.3.3.3 DIM (TIM) IMD Function

Test Signal Compatibility	2.96-3.15 kHz squarewave mixed with 14 – 15 kHz sine probe tone
IMD Measured ¹⁷	u_4 and u_5 per IEC 268-3 (1986)
Measurement Range	0-20%
Accuracy	±0.7 dB
Residual IMD ¹⁶	≤0.0020%

¹⁶ System specification measured with the System Two analog generator. Valid for input levels ≥200 mVrms.

¹⁷ IEC 268-3 defines nine possible DIM products. The System Two IMD option analyzer is sensitive only to the u_4 and u_5 products using the simplified measurement technique proposed by Paul Skritek. DIM measurements using this technique will typically be 6-8 dB lower (better) than the results obtained using FFT-based techniques which sum all nine products.

2.3.4 Wow & Flutter Measurements

with option "W&F"

Option "W&F" adds the capability to make both conventional wow & flutter and scrape flutter measurements (using the technique developed by Dale Manquen of Altair Electronics, Inc.). The demodulated W&F signal can also be selected for FFT analysis in SYS-2422 and SYS-2522 configurations.

Test Signal Compatibility	
Normal	2.80 kHz-3.35 kHz
"High-band"	11.5 kHz-13.5 kHz
Measurement Range	0 to 1.2%
Accuracy (4 Hz)	$\pm(5\%$ of reading + 0.0005%)
Detection Modes	IEC/DIN (quasi-peak per IEC-386), NAB (average), JIS (per JIS 5551)
Response Selections	
Weighted	4 Hz bandpass per IEC/DIN/NAB
Unweighted	0.5 Hz-200 Hz
Scrape ¹⁸	200 Hz-5 kHz
Wideband ¹⁸	0.5 Hz-5 kHz
Residual W+F	
Weighted	$\leq 0.001\%$
Unweighted	$\leq 0.002\%$
Scrape or Wideband	$\leq 0.005\%$
Minimum Input	5 mV (20 mV for specified residual)
Settling Time	
IEC/DIN or NAB	Typically 3-6 seconds
JIS	Typically 15-20 seconds

¹⁸

Operational with high-band test signals (11.5 kHz-13.5 kHz) only. Upper -3 dB rolloff is typically 4.5 kHz using 12.5 kHz.

2.4 Option Filters

Up to seven option filters can be installed in the System Two Cascade analyzer for weighted noise or other special measurements. Option filters are selected one at a time and are cascaded with the standard bandwidth-limiting filters.

The following tables list only the most popular types. Contact Audio Precision for a quotation regarding other possible designs. The maximum usable dynamic range will be limited to about 40 – 50 dB because system auto-ranging is based upon the peak value of the unfiltered wideband signal. Custom designs may be constructed on the FIL-USR blank card.

2.4.1.1 Weighted Noise Measurement

FIL-AWT	"A" weighting per IEC Rec 179
FIL-CCR	Weighting per CCIR Rec 468 and DIN 45404 (Also for CCIR/ARM)
FIL-CIT	Weighting per CCITT Rec P53
FIL-CMS	"C-message" per BSTM 41004 and ANSI/IEEE Std 743-1984
FIL-CWT	"C" weighting per IEC Rec 179

2.4.1.2 Precision De-emphasis Family

FIL-D50	50 μ s \pm 1%
FIL-D50E	50 μ s \pm 1% + 15.625 kHz notch
FIL-D50F	50 μ s \pm 1% + 19.0 kHz notch
FIL-D75	75 μ s \pm 1%
FIL-D75B	75 μ s \pm 1% + 15.734 kHz notch
FIL-D75F	75 μ s \pm 1% + 19.0 kHz notch

2.4.1.3 Precision Sharp Cutoff Low-Pass Family

Family Response	-3 dB at $f_c \pm 1.5\%$; ± 0.2 dB to $0.5 f_c$, ± 0.4 dB to $0.8 f_c$; <-50 dB above $1.8 f_c$
FLP-10K	$f_c = 10.0$ kHz, quasi-elliptic
FLP-15K	$f_c = 15.0$ kHz, quasi-elliptic
FLP-18K	$f_c = 18.0$ kHz, quasi-elliptic
FLP-19K	$f_c = 19.0$ kHz, quasi-elliptic
FLP-20K	$f_c = 20.0$ kHz, quasi-elliptic
<i>See also FLP-A20K under Miscellaneous</i>	

2.4.1.4 Bandwidth Limiting, Low-Pass

FLP-400	400 Hz \pm 3%, 5-pole
FLP-500	500 Hz \pm 3%, 5-pole
FLP-1K	1 kHz \pm 3%, 5-pole Butterworth

Option Filters

System Two Cascade Specifications

FLP-3K	3 kHz \pm 3%, 7-pole Butterworth
FLP-4K	4 kHz \pm 3%, 7-pole Butterworth
FLP-8K	8 kHz \pm 3%, 7-pole Butterworth
FLP-50K	50 kHz \pm 5%, 3-pole Butterworth

2.4.1.5 Bandwidth Limiting, High-Pass

FHP-70	70 Hz \pm 3%, 8-pole
FHP-400	400 Hz \pm 3%, 9-pole
FHP-2K	2 kHz \pm 3%, 9-pole
FHP-20K	20 kHz \pm 3%, (per AES-17)

2.4.1.6 1/3-Octave (Class II) Bandpass Family

Family Response	Class II (4-pole) \pm 0.2 dB from 0.97 f_o to 1.03 f_o ; <-12 dB at 0.8 f_o and 1.25 f_o ; <-32 dB at 0.5 f_o and 2.0 f_o
FBP-120	f_o = 120 Hz
FBP-180	f_o = 180 Hz
FBP-250	f_o = 250 Hz
FBP-300	f_o = 300 Hz
FBP-400	f_o = 400 Hz
FBP-500	f_o = 500 Hz
FBP-600	f_o = 600 Hz
FBP-666	f_o = 666 Hz
FBP-800	f_o = 800 Hz
FBP-945	f_o = 945 Hz
FBP-1000	f_o = 1.00 kHz
FBP-1200	f_o = 1.20 kHz
FBP-1500	f_o = 1.50 kHz
FBP-2000	f_o = 2.00 kHz
FBP-3000	f_o = 3.00 kHz
FBP-3150	f_o = 3.15 kHz
FBP-4000	f_o = 4.00 kHz
FBP-4500	f_o = 4.50 kHz
FBP-5000	f_o = 5.00 kHz
FBP-6000	f_o = 6.00 kHz
FBP-8000	f_o = 8.00 kHz
FBP-10000	f_o = 10.0 kHz
FBP-12500	f_o = 12.5 kHz
FBP-15000	f_o = 15.0 kHz
FBP-16000	f_o = 16.0 kHz
FBP-20000	f_o = 20.0 kHz
FBP-22000	f_o = 22.0 kHz

2.4.1.7 Receiver Testing

FIL-RCR	200 Hz – 15 kHz + 19.0 kHz notch
FIL-IECR	20 Hz – 15 kHz + 15.625 kHz notch

2.4.1.8 Miscellaneous

FBP-500X	High-Q 500 Hz bandpass for CD dac linearity measurements
FLP-A20K	Apogee 20 kHz "Brick Wall" filter (OEM design)
FIL-USR	Kit for building custom filters

Note: The optional filters described here can be added to the standard band-limiting filters shown in Figure 2-6.

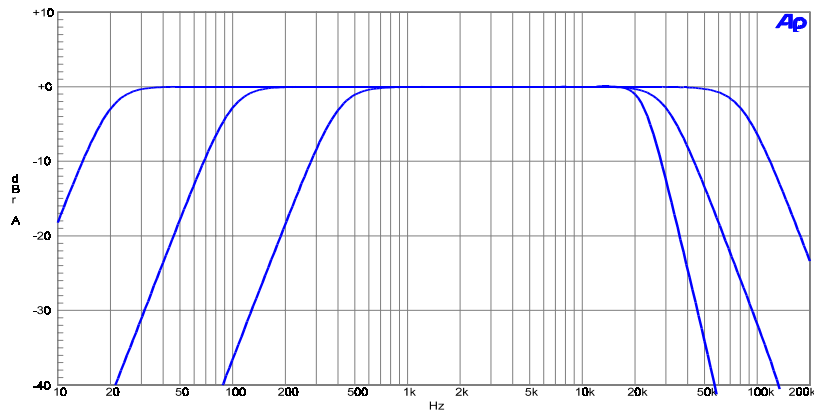

Figure 2-6. Standard Band-limiting filters included with every System Two. High pass selectable 22 Hz, 100 Hz, 400 Hz; Low pass selectable 22 kHz, 30 kHz, 80 kHz.

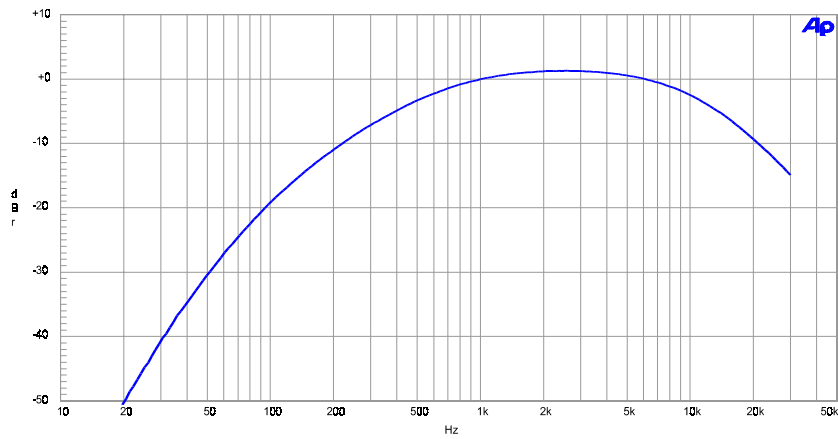

Figure 2-7. FIL-AWT ANSI-IEC "A" Weighting Filter

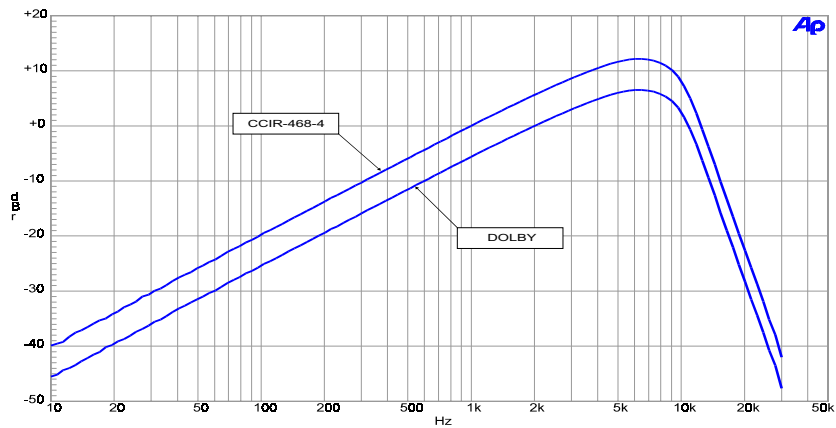

Figure 2-8. FIL-CCR CCIR-468 / DIN 45404 Noise Weighting Filter

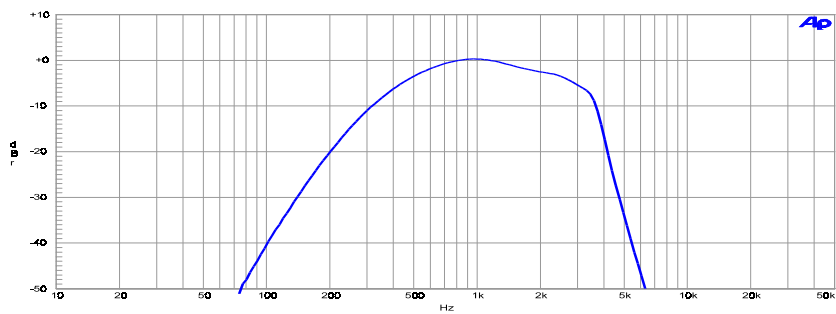

Figure 2-9. FIL-CIT CCITT P53 Noise Weighting Filter

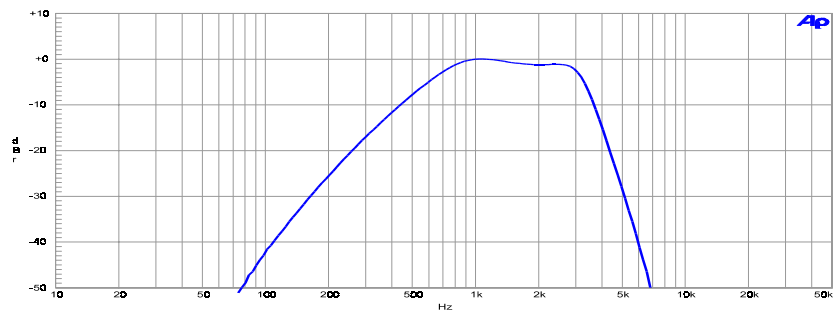

Figure 2-10. FIL-CMS C-Message Weighting Filter (ANSI/IEEE 743-1984)

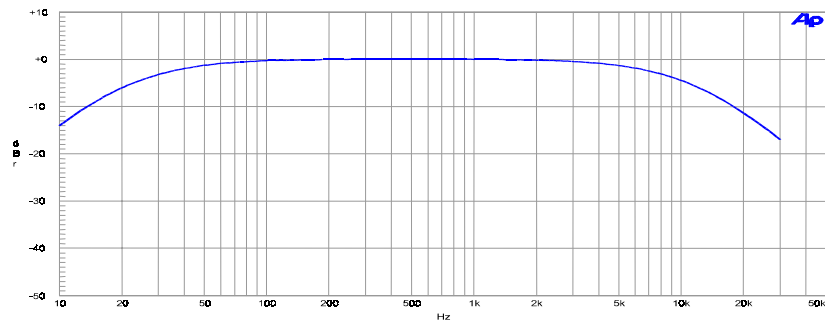

Figure 2-11. FIL-CWT "C" Weighting (IEC-179)

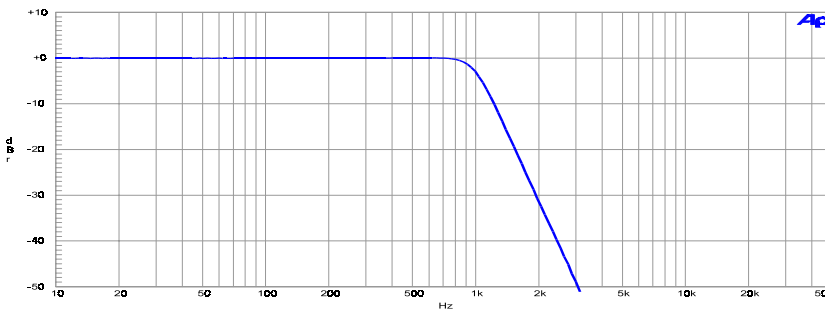

Figure 2-12. FLP-1K 1 kHz Low Pass 5-pole Butterworth Filter

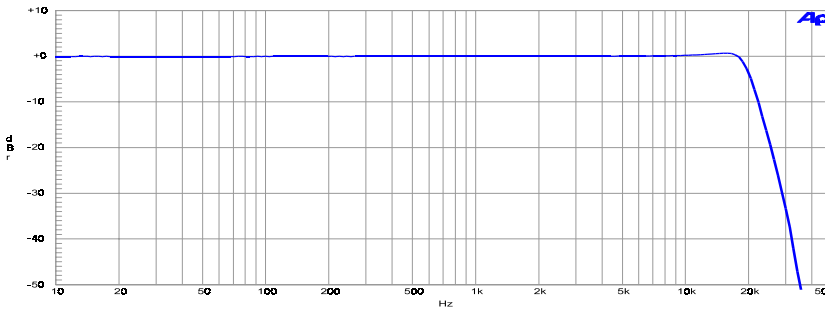

Figure 2-13. FLP-20K 20.0 kHz Quasi-elliptic sharp cutoff Low Pass Filter

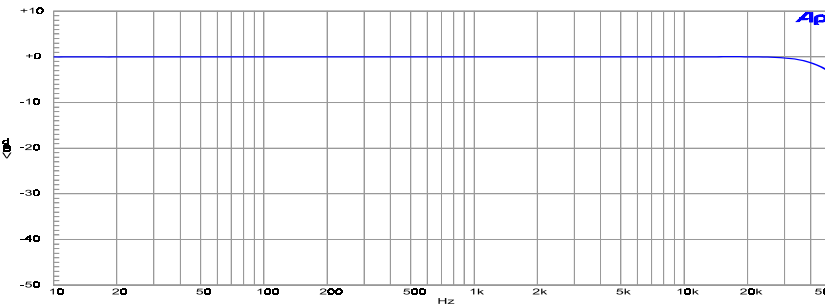

Figure 2-14. FLP-50K 50 kHz 3-pole Butterworth Low Pass Filter

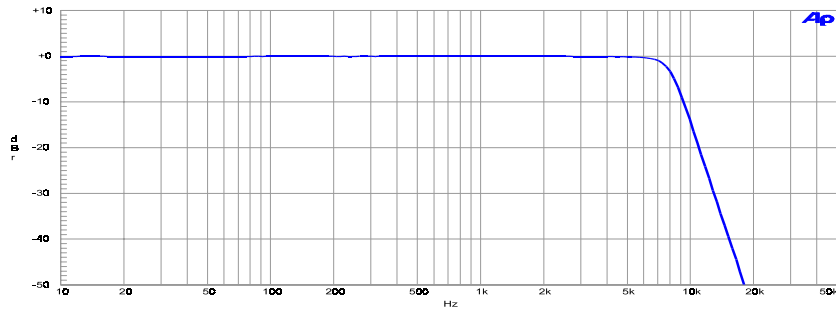

Figure 2-15. FLP-8K 8 kHz 7-pole Butterworth Low Pass Filter

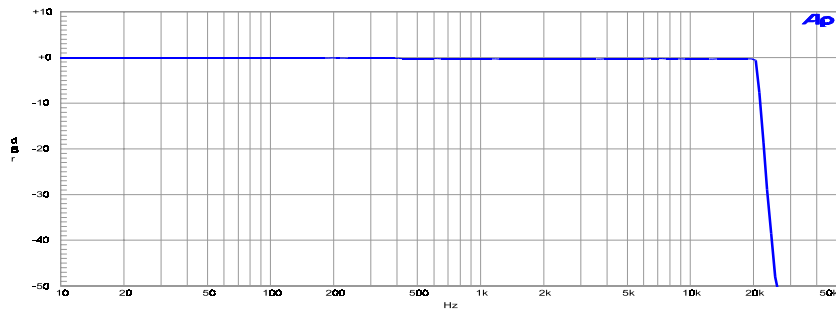

Figure 2-16. FLP-A20K Apogee "Brick Wall" 20 kHz Low Pass Filter

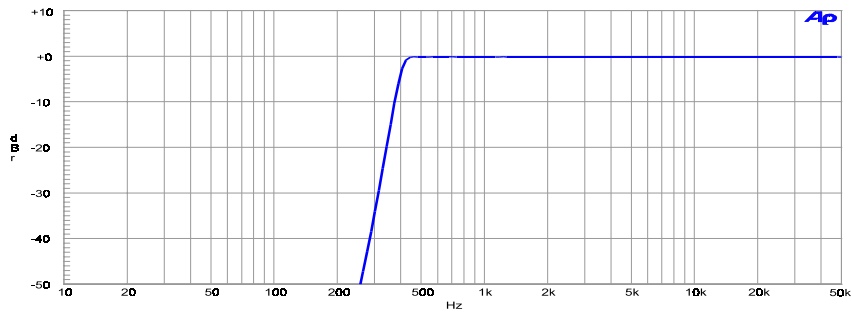

Figure 2-17. FHP-400 400 Hz 9-pole High Pass Filter

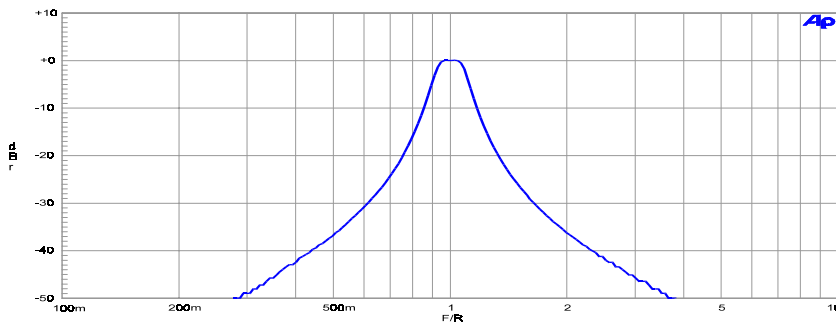

Figure 2-18. FBP-XXXX Fixed 1/3 Octave Band Pass Filter

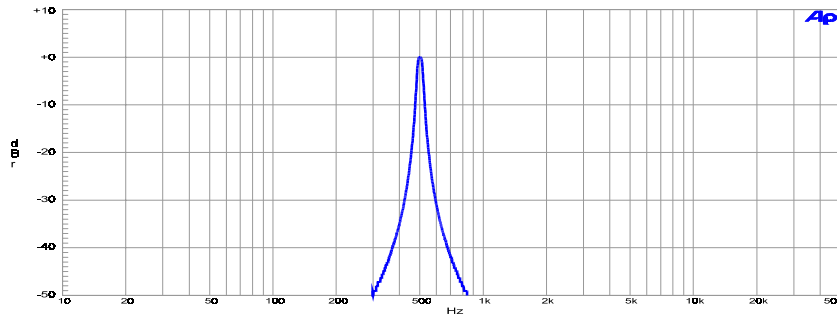

Figure 2-19. FBP-500X High-Q 500 Hz Band Pass Filter (for CD linearity testing)

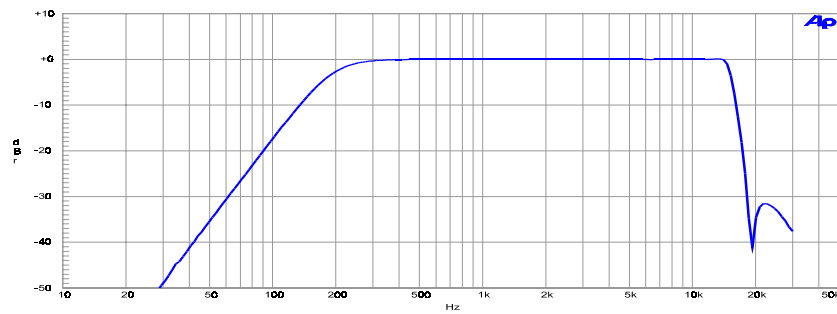

Figure 2-20. FIL-RCR 200 Hz to 15 kHz with 19 kHz (FM) notch Receiver Testing Filter

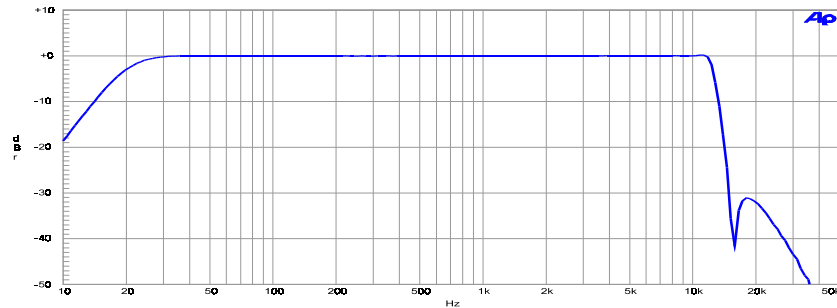

Figure 2-21. FIL-IECR 20 Hz to 15 kHz with 15.625 kHz (PAL) notch Receiver Testing Filter

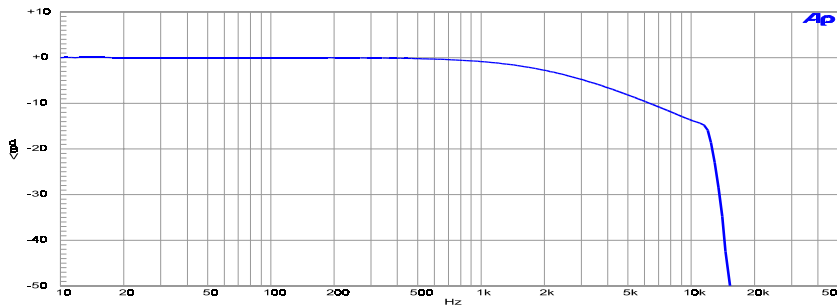

Figure 2-22. FIL-D75B 75 μ s with 15.734 kHz (NTSC) notch De-emphasis Filter

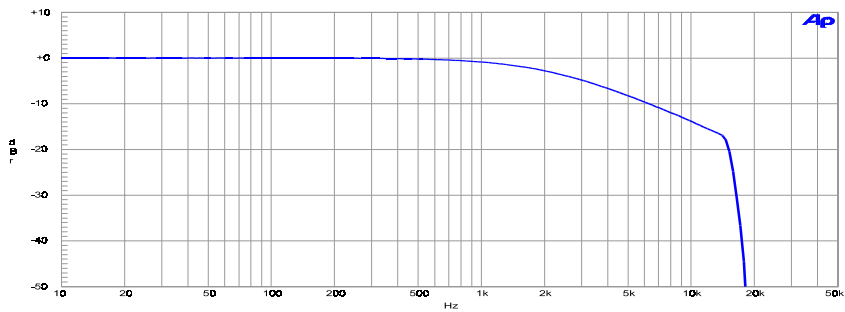

Figure 2-23. FIL-D75F 75 μ s with 19 kHz (FM) notch De-emphasis Filter

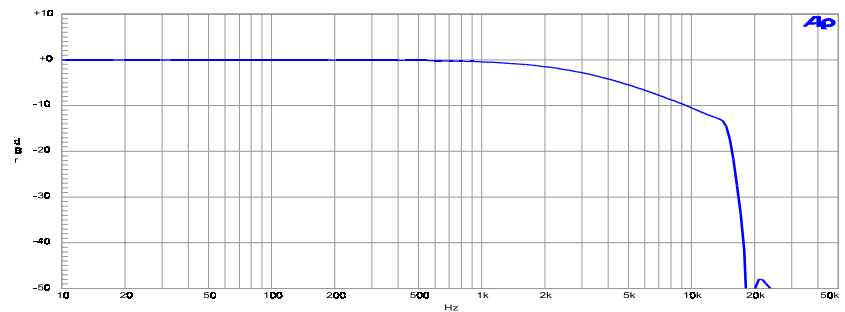

Figure 2-24. FIL-D50F 50 μ s with 19 kHz (FM) notch De-emphasis Filter

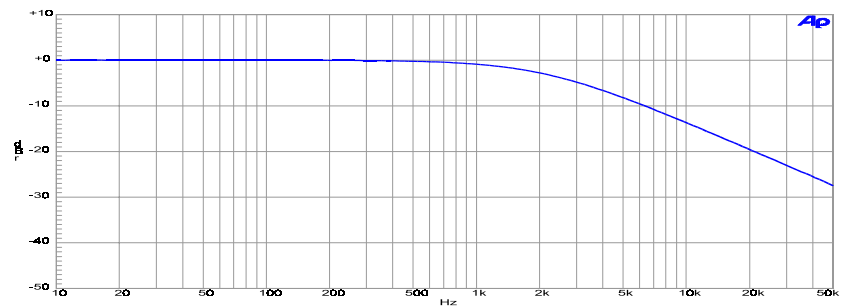

Figure 2-25. FIL-D75 75 μ s De-emphasis Filter

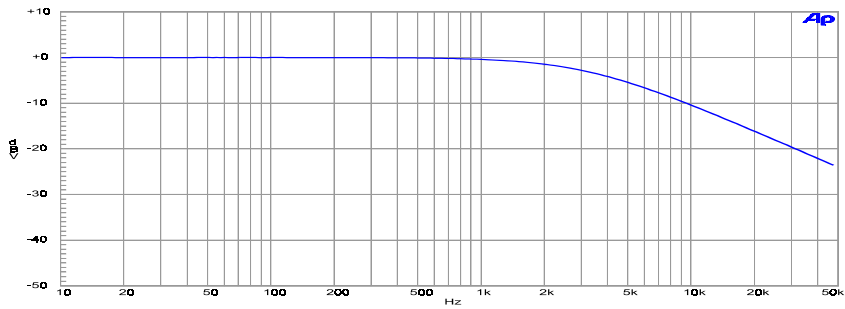

Figure 2-26. FIL-D50 50 μ s De-emphasis Filter

2.5 DSP Analysis of Analog Signals

Available only in models SYS-2422 and SYS-2522. Signals connected to the analog analyzer input connector may also be internally routed through stereo A/D converters for enhanced analysis capabilities. There are two selectable converters. The high resolution converter (“HiRes A/D”) is optimized for signal analysis and FFT displays up to 30 kHz. It offers the best residual noise and distortion performance. The high bandwidth converter (“HiBW A/D”) is optimized for signal analysis up to 120 kHz.

2.5.1 High Resolution Converter

A/D Resolution	24-bit sigma-delta
Sample Rate (SR)	7.2ks/s to 108ks/s variable; or 65.536ks/s fixed
Flatness	± 0.01 dB to 0.450 SR or 20 kHz, whichever is lower
Alias Rejection ¹⁹	typ 115 dB for signals >0.554 SR
Distortion	-105 dB for SR ≤ 65.536 ks/s, -102 dB for SR up to 100 ks/s
Maximum usable BW	30 kHz with SR = 65.536 ks/s, 45 kHz with SR = 100 ks/s

2.5.2 High Bandwidth Converter

A/D Resolution	16-bit sigma-delta
Sample Rate (SR)	56 ks/s to 216 ks/s variable; or 131.072 ks/s or 262.144 ks/s fixed
Flatness (1 kHz ref)	± 0.01 dB to 20 kHz, ± 0.10 dB to 120 kHz (262.144 ks/s)
Alias Rejection ¹⁹	typ 85 dB for signals >0.540 SR
Distortion	-92 dB for SR ≤ 216 ks/s, -90 dB with SR = 262.144 ks/s

2.5.3 FFT Signal Analyzer

(fft)

Acquisition Length	800 - 256 k samples in 11 steps
Transform Length	256-32768 samples in binary steps
Processing	48 bit

¹⁹ Alias rejection is provided by digital filters within the respective A/D converters.

Windows (see Figure 2-27 and Figure 2-28)	Blackman-Harris (4 term with -92 dB sidelobe) Hann Flat-top Equiripple (-145 dB sidelobes) None None, sync to sine Hamming Gaussian Rife-Vincent 4-term Rife-Vincent 5-term
Amplitude Accuracy	±0.1 dB, 20 Hz-20 kHz, using Flat-top window
Averaging	1-4096 in binary steps, averaging algorithm is power (spectrum only) or synchronous
Waveform Display Modes	Normal, interpolate, peak, max
Frequency Display Modes	Peak pick, individual bin
Sync to Sine Window	
Frequency Range	7 th bin to 45% of sample rate (21.6 kHz at 48 k samples/s)
Amplitude Accuracy	±0.025 dB
Distortion Products	-120 dB

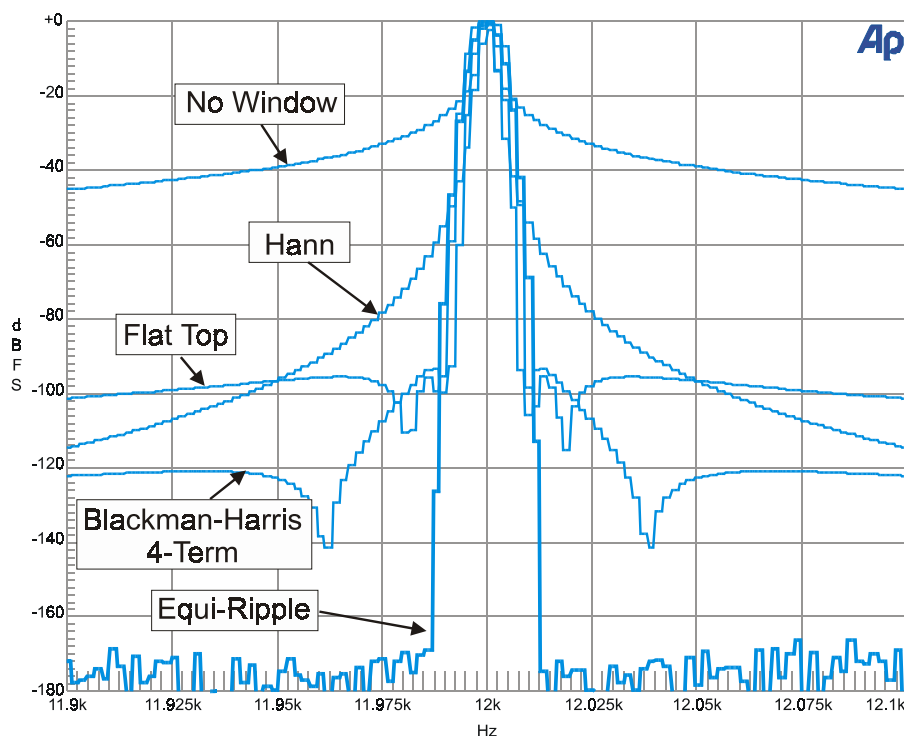

Figure 2-27. Windows available with FFT function (figure 1 of 2)

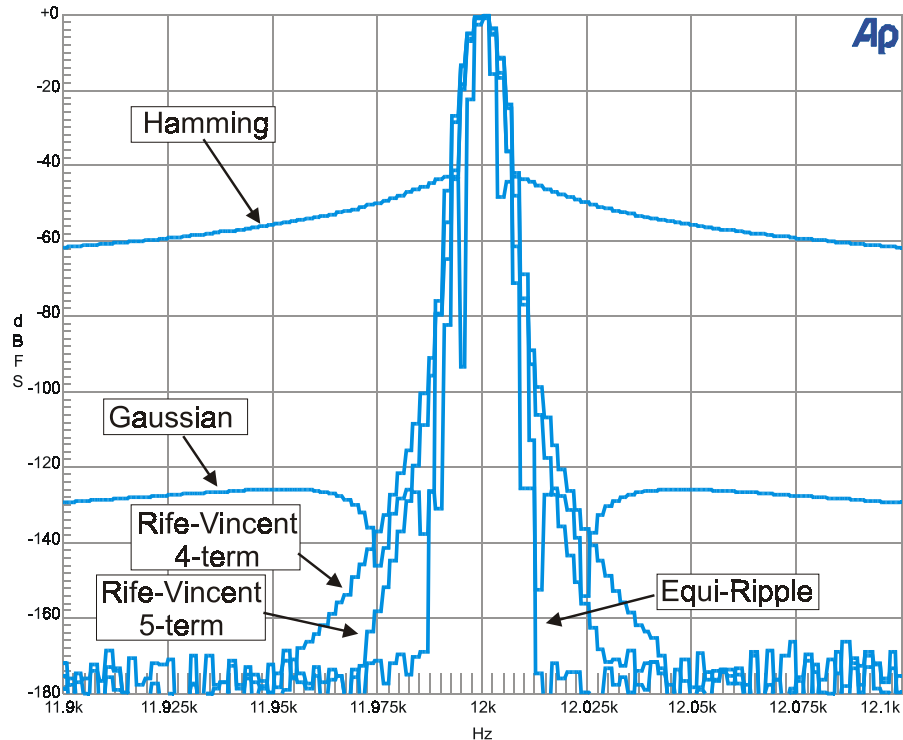

Figure 2-28. Windows available with FFT function (figure 2 of 2)

2.5.4 DSP Audio Analyzer

(analyzer)

2.5.4.1 Wideband Level/Amplitude

Frequency Range	<5Hz to 45.8% of sample rate 5 Hz to 20.2 kHz at 44.1 k samples/s 5 Hz to 22.0 kHz at 48 k samples/s 5 Hz to 44.0 kHz at 96 k samples/s
High pass Filters	<10 Hz, 4-pole Butterworth 22 Hz, 4-pole Butterworth 100 Hz, 4-pole Butterworth 400 Hz, 4-pole Butterworth 400 Hz, 10-pole elliptical <i>when not using notch filter or bandpass mode</i> (response is -120 dB for ≤ 220 Hz, ± 0.1 dB for ≥ 400 Hz)
Low pass Filters	20 kHz 6-pole elliptic low-pass 15 kHz, 6-pole elliptic low-pass <i>both: 0.1dBpp ripple, ≥ 110 dB stopband attenuation</i>

Weighting Filters

ANSI-IEC "A" weighting, Type 0
 CCIR QPk per CCIR Rec 468
 CCIR RMS per AES 17
 C-message per IEEE Std 743-1978
 CCITT per CCITT Rec. P.53
 "F" weighting corresponding to 15 phon loudness contour (see Figure 2-29)

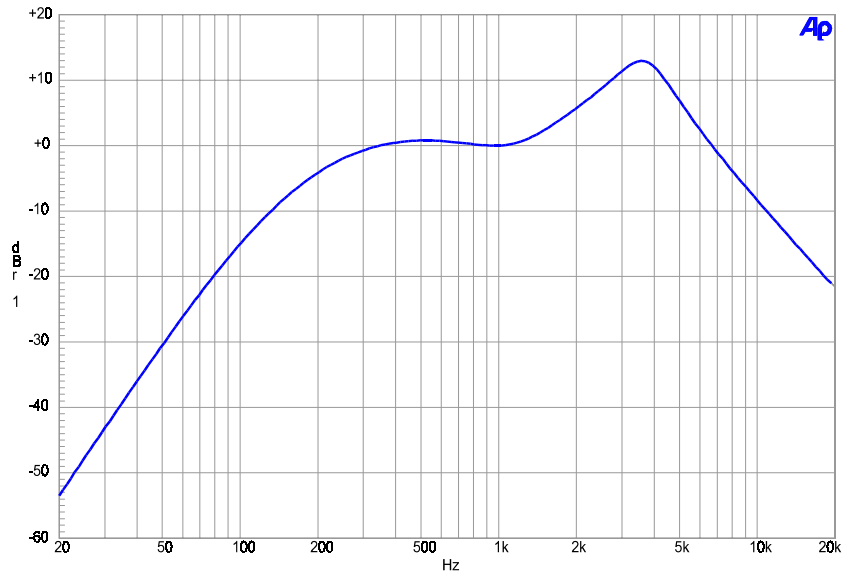

Figure 2-29. Digital Analyzer F-weighting curve

2.5.4.2 Narrow Band Amplitude

Frequency Range	<5Hz to 40% of sample rate
	5 Hz to 17.6 kHz at 44.1 k samples/s
	5 Hz to 19.2 kHz at 48 k samples/s
	5 Hz to 38.4 kHz at 96 k samples/s
Filter Shape	10-pole, Q=19 (BW = 5.3% of f_o) (see Figure 2-30)

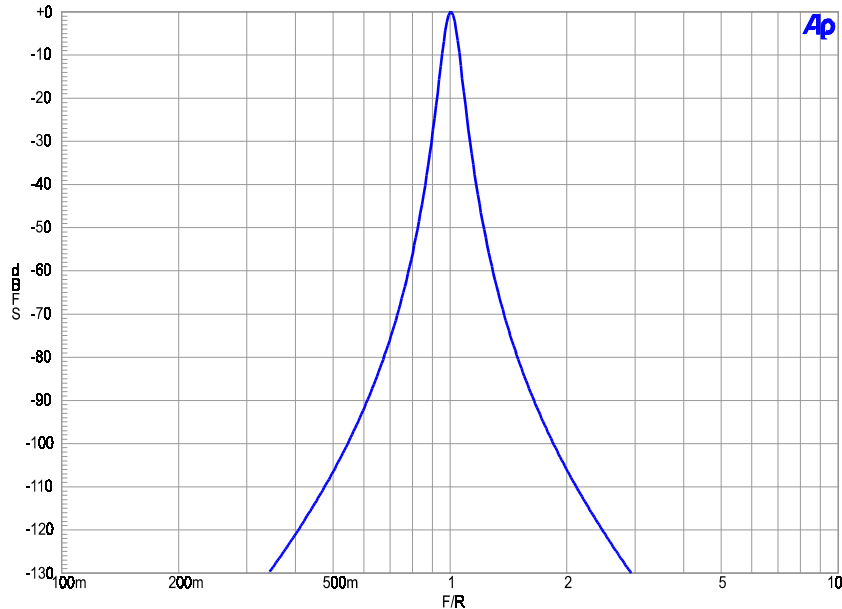

Figure 2-30. Digital Domain Band Pass filter response.

2.5.4.3 THD + N Measurements

Frequency Range	<5Hz to 45% of sample rate
	5 Hz to 19.9 kHz at 44.1 k samples/s
	5 Hz to 21.6 kHz at 48 k samples/s
	5 Hz to 43.2 kHz at 96 k samples/s
High pass Filters	<10 Hz, 4-pole Butterworth 22 Hz, 4-pole Butterworth 100 Hz, 4-pole Butterworth 400 Hz, 4-pole Butterworth
Low pass Filters	20 kHz, 6-pole elliptic low-pass 15 kHz, 6-pole elliptic low-pass <i>both: 0.1dBpp ripple, ≥ 110 dB stopband attenuation</i>
Weighting Filters	ANSI-IEC "A" weighting, per IEC Rec 179 CCIR QPk per CCIR Rec 468 CCIR RMS per AES 17 C-message per IEEE Std 743-1978 CCITT per CCITT Rec. P.53 "F" weighting corresponding to 15 phon loudness contour (see Figure 2-29 on page 2-27)

2.5.4.4 Frequency Measurements

Range	5 Hz to 47% of sample rate 5 Hz - 21.0 kHz at 44.1 k samples/s 5 Hz - 23.0 kHz at 48.0 k samples/s 5 Hz - 46 kHz at 96 k samples/s
Accuracy	±0.01% of reading or 0.0001% of sample rate, whichever is greater
Resolution	0.003% of reading or 0.0001% of sample rate, whichever is greater

2.5.5 Quasi-Anechoic Acoustical Tester

(MLS)

Signals	Four pink sequences, four white sequences
Frequency Range	Sample rate/2000 to sample rate/2
Frequency Resolution (Max)	1.465 Hz at 48.0 k samples/s
Acquisition Length	32767 samples or 131071 samples
FFT Length	32768
Energy Time Windows	half Hann Hann <240 Hz > 8 kHz <120 Hz > 16 kHz
Time Windows (percent of data record to transition from 0 to full amplitude)	<5% <10% <20% <30%

2.5.6 Multitone Audio Analyzer

(fasttest)

Acquisition Length	512-32768 samples in binary steps
Transform Length	512-32768 samples in binary steps
Processing	48 bit
Measurements	Level vs frequency (Response), Total distortion vs frequency, Noise vs frequency, Phase vs frequency, Crosstalk vs frequency, Masking curve
Frequency Resolution	2.93 Hz with 96.0 k samples/s 1.345 Hz with 44.1 k samples/s 1.465 Hz with 48.0 k samples/s
Frequency Error Correction Range	±3%
Distortion	≤-115 dB

2.6 Digital Signal Generator

Available in the SYS-2500 and SYS-2522 configurations only. The System Two Cascade digital generator consists of a DSP signal generator, selectable pre-emphasis filters, two hardware dither generators, and several digital output stages supporting the most popular formats.

All digitally-generated sine variants, MLS, and IMD signals for the digital domain outputs are independently generated and may be selected simultaneously but independently from the concurrently available digital signals for the analog domain via the D to A converter outputs.

2.6.1 Digital Output Characteristics

Output Formats	AES/EBU (per AES3-1992) SPDIF-EIAJ Optical (Toslink®) General purpose serial General purpose parallel Serial interface to chip level via optional SIA-2322 accessory
Sample Rates	28.8 kHz-100 kHz AES/EBU, 64 kHz - 200 kHz dual connector AES/EBU, general purpose serial; 8 kHz to 200 kHz parallel, independent from input sample rate
Sample Rate Resolution	1/64 Hz (approx. 0.0156 Hz)
Sample Rate Accuracy	±0.0002% [±2 PPM] using internal reference, lockable to external reference
Word Width	8 to 24 bits
Output impedance	
Balanced (XLR)	110 Ω
Unbalanced (BNC)	75 Ω approx.

2.6.2 Digital Signal Generation

2.6.2.1 Sine Wave

Frequency Range	10 Hz to 47% of sample rate (22.56 kHz at 48 k samples/s)
Frequency Resolution	Sample Rate ÷ 2 ²³ (typically 0.006 Hz at 48 k samples/s)
Flatness	±0.001 dB
Harmonics and Spurious Products	≤0.00001% [-160 dB]

2.6.2.2 Sine Burst

Sine burst with rectangular envelope

Frequency Range	10 Hz to 47% of sample rate (22.56 kHz at 48 k samples/s)
Frequency Resolution	Sample Rate $\div 2^{23}$ (typically 0.006 Hz at 48 k samples/s)
Interval	2 – 65536 cycles
Burst On	1 to number of Interval cycles minus 1
Flatness	± 0.001 dB
Harmonics and Spurious Products	$\leq 0.00001\%$ [-160 dB]

2.6.2.3 Variable Phase Sine Wave

Two sine waves, same frequency, independently settable phase

Frequency Range	10 Hz to 47% of sample rate (22.56 kHz at 48 k samples/s)
Frequency Resolution	Sample Rate $\div 2^{23}$ (typically 0.006 Hz at 48 k samples/s)
Phase Range	± 180 deg.
Phase Resolution	0.01 deg.
Flatness	± 0.001 dB
Harmonics and Spurious Products	$\leq 0.00001\%$ [-140 dB]

2.6.2.4 Stereo Sine Wave

Sine wave of independent frequency and amplitude on each channel

Frequency Range	10 Hz to 47% of sample rate (22.56 kHz at 48 k samples/s) Stereo frequencies may be set independently for each channel
Frequency Resolution	Sample Rate $\div 2^{23}$ (typically 0.006 Hz at 48 k samples/s)
Flatness	± 0.001 dB
Harmonics and Spurious Products	$\leq 0.00001\%$ [-160 dB]

2.6.2.5 Dual Sine Wave

Twin sine waves of independent frequency and settable amplitude ratio; applied to both output channels

Frequency Range	10 Hz to 47% of sample rate (22.56 kHz at 48 k samples/s)
Frequency Resolution	Sample Rate $\div 2^{23}$ (typically 0.006 Hz at 48 k samples/s)
Flatness	± 0.001 dB
Harmonics and Spurious Products	$\leq 0.00001\%$ [-160 dB]
Amplitude ratio	0 dB to -120 dB

2.6.2.6 Sine + Offset

Sine wave plus a constant value

Frequency Range	10 Hz to 47% of sample rate (22.56 kHz at 48 k samples/s)
Frequency Resolution	Sample Rate $\div 2^{23}$ (typically 0.006 Hz at 48 k samples/s)
Offset Amplitude	Sinewave amplitude + offset amplitude \leq 100% FS
Flatness	± 0.001 dB
Harmonics and Spurious Products	$\leq 0.00001\%$ [-160 dB]

2.6.2.7 Shaped Sine Burst

Sine burst with raised cosine envelope (see Figure 2-31)

Frequency Range	10 Hz to 47% of sample rate (22.56 kHz at 48 k samples/s)
Frequency Resolution	Sample Rate $\div 2^{23}$ (typically 0.006 Hz at 48 k samples/s)
Interval	2 – 65536 cycles
Burst On	1 to number of Interval cycles minus 1
Flatness	± 0.001 dB
Harmonics and Spurious Products	$\leq 0.00001\%$ [-160 dB]

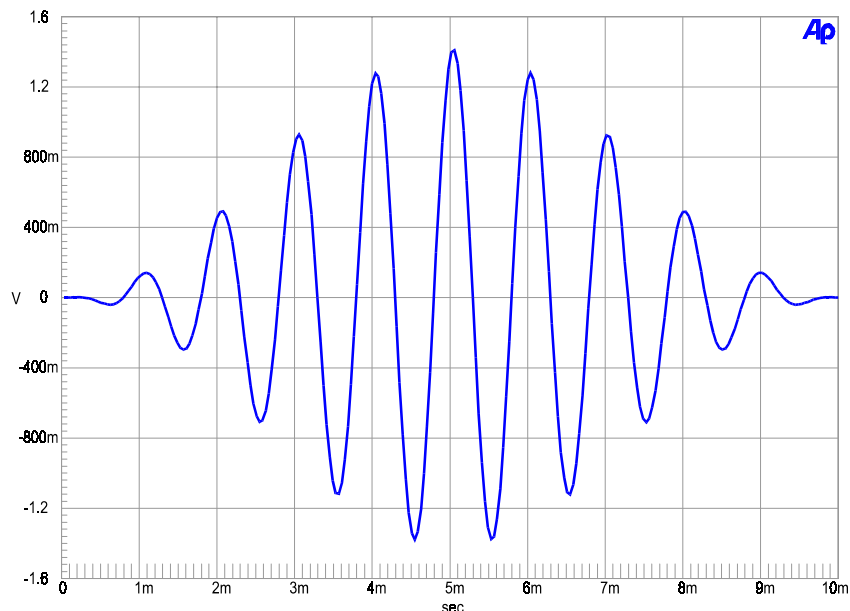

Figure 2-31. Shaped Sine Burst signal (1 kHz, 10 cycles)

2.6.2.8 Square Wave

Frequency Range	<1 Hz to 1/6 sample rate (7350 Hz at 44.1 k samples/s, 8000 Hz at 48 k samples/s, 16000 Hz at 96 k samples/s)
Frequencies available	≤ 1 Hz to $f_s \div 6$, in even integer divisors
Even Harmonic Content	$\leq 0.00001\%$ [-160 dB]

2.6.2.9 SMPTE/DIN Waveform

Upper Tone Frequency Range	2 kHz to 47% of sample rate (22.56 kHz at 48 k samples/s)
Lower Tone Frequency Range	40 Hz – 500 Hz
Frequency Resolution	Sample Rate $\div 2^{23}$ (typically 0.006 Hz at 48 k samples/s)
Flatness	± 0.001 dB
Amplitude Ratio	1:1 to 10:1 [0 to 20 dB] (LF:HF)
Intermodulation Components	$\leq 0.00001\%$ [-160 dB] at 4:1 ratio

2.6.2.10 CCIF and DFD IMD Waveforms

Center Frequency Range	3000 Hz to (47% of sample rate – $\frac{1}{2}$ IM frequency) (22.51 kHz at 48 k samples/s; 20.67 kHz at 44.1 k samples/s)
IM Frequency Range	80 Hz-2000 Hz
Frequency Resolution	Sample Rate $\div 2^{23}$ (typically 0.006 Hz at 48 k samples/s)
Flatness	± 0.001 dB
Intermodulation Components	$\leq 0.00001\%$ [-160 dB]

2.6.2.11 DIM IMD Waveform

Sine wave Frequency	100/21 * squarewave frequency (15 kHz at 44.1 k samples/s; 14285.7 Hz at 48 k samples/s)
Sine wave Frequency Resolution	Data Rate $\div 2^{23}$ (typically 0.006 Hz at 48 k samples/s)
Square wave Frequency sample rate	
<35 k samples/s	1/10 sample rate
35 k samples/s to 42 k samples/s	1/12 sample rate
42 k samples/s to 46 k samples/s	1/14 sample rate (3150 Hz at 44.1 k samples/s)
≥ 46 k samples/s	1/16 sample rate (3000 Hz at 48 k samples/s)
Amplitude Ratio	4:1 (squarewave:sinewave)
Intermodulation Components	$\leq 0.00001\%$ [-160 dB]
Even Harmonic Content	$\leq 0.00001\%$ [-160 dB]

2.6.2.12 Noise

Types	Pink, White, Burst, USASI
-------	---------------------------

2.6.2.13 Special Signals

Monotonicity	Low level staircase waveform for D/A linearity testing
J-Test	Produces a maximum amount of data-induced jitter on low-bandwidth transmission links
Polarity	Two sinewaves phased for reinforcement with normal polarity
Walking Ones	A single binary one value "walked" from LSB to MSB
Walking Zeros	A single binary zero value "walked" from LSB to MSB
Constant Value (applies only to DC)	(Digital DC)
Bittest Random	Random binary states of all bits
Pass Thru	Passes the signal from the rear panel Ref Input
Resolution	32 bit when using triangular dither

2.6.2.14 Quasi-Anechoic Acoustical Tester

(MLS, Page 2-29)

Signals	Four pink sequences, four white sequences
Frequency Range	DC to 50% of sample rate
Repetition Rate	32767 samples or 131071 samples, automatically selected between 32 k or 131 k sequence as furnished by generator

2.6.2.15 Multitone Signals

Stored waveform consisting of multiple sine waves, each at independent frequency, amplitude, and phase

Number of Tones	1 to 128 typical, 8191 maximum
Frequency Range	DC to $f_s \div 2$
Frequency Resolution	Sample Rate $\div 2^{14}$ (typically 2.93 Hz at 48 k samples/s)
Flatness	± 0.001 dB
Residual Distortion	$\leq 0.00001\%$ [-140 dB]

2.6.2.16 Arbitrary Waveforms

Length	256-16324 points per channel, user specified waveform. Utility is provided to prepare a time record file from user specified frequency, amplitude, and phase data.
--------	--

2.6.2.17 Dither (all waveforms)

Probability Distribution	Triangular or rectangular; true random; independent for each channel
Spectral Distribution	Flat (white) or Shaped (+6 dB/oct)
Amplitude	8-24 bit or off

2.6.2.18 Pre-Emphasis Filters (all waveforms)

Filter Shape	50/15 μ s or J17
Response Accuracy	± 0.02 dB 10 Hz to 45% sample rate
Residual Distortion	$\leq 0.00003\%$ [-130 dB]

2.7 AES/EBU Interface Generation

2.7.1.1 Interface Signal

Amplitude Range	(Fixed RISE/FALL time)
Balanced (XLR)	0-10.24 Vpp, $\pm(10\% + 80$ mV) into 110 Ω in 40 mV steps
Unbalanced (BNC)	0 to 2.048 Vpp, $\pm(8\% + 16$ mV) into 75 Ω in 8 mV steps
Optical (Toslink [®])	0 to 256% of nominal intensity in 1% steps
Channel Status Bits	Full implementation, English language decoded, Pro or consumer or hex formats; independent in each channel
User Bits	set to 0
Validity Flag	selectable, set or cleared

2.7.1.2 AES/EBU Impairments

Variable rise/fall time	16 ns to 400 ns, $\pm 20\%$
Induced Jitter	Selectable sinewave, squarewave, or wideband noise
Jitter Freq Range ²⁰	2.00 Hz-200 kHz, <0.1 Hz resolution
Jitter Ampl Range ²⁰	0-1.27 UI (peak) in 0.005 UI steps; 1.3-12.7 UI (peak) in 0.05 UI steps
Jitter Accuracy	$\pm(10\% + 0.005$ UI) at 500 Hz
Jitter Flatness	± 1 dB, 100 Hz to 20 kHz
Residual Jitter ²¹	
48 ks/s	≤ 0.010 UI [1.6 ns]
96 ks/s	≤ 0.020 UI [1.6 ns]
Spurious Jitter Products	typ <0.001 UI or 30 dB below jitter signal, whichever is larger
Normal Mode Noise	
Balanced	0-2.55 Vpp, $\pm(10\% + 100$ mV), in 10 mV steps
Unbalanced	0-635 mVpp, $\pm(10\% + 25$ mV), in 2.5 mV steps
Common Mode Freq	20 Hz to 40 kHz <0.1 Hz resolution
Common Mode Ampl	0-20 Vpp, $\pm(10\% + 200$ mV), in 80 mV steps
Cable Simulation	Multi-pole fit to AES 3-1992 filter to simulate the response degradation of a worst case long cable
Offset from reference	-64 to +63.5 UI, in 0.5 UI steps

²⁰ Combinations of jitter amplitude and frequency must not result in greater than 50% reduction in transmitted bit width.

²¹ System specification including analyzer contribution. The following conditions must be met: (1) the jitter generator amplitude must be turned off or set for 0.0000 UI, (2) all other forms of impairment must be off or disabled, and (3) the digital output must be ≥ 1.0 Vpp (XLR) or ≥ 250 mVpp (BNC).

2.7.2 Reference Input Characteristics

A rear panel reference input is provided to synchronize the internal sample clock generator to an external signal. The output sample rate (ISR) is not dependent upon the rate or characteristics of the external reference. OSR need not be at 1:1 ratio to reference but will be phase-locked to reference over full specified range of OSR and Reference inputs. Reference input jitter below 5 Hz will pass to the output; jitter above 5 Hz is attenuated 6 dB/octave.

Input Formats	AES/EBU (per AES 3-1992), NTSC/PAL/SECAM video, or squarewave
Input Sample Rates/ Frequency Range	28.8 kHz-100 kHz AES/EBU, 8.0 kHz-10.0 MHz squarewave
Sample Rate Resolution	
8 kHz – 65 kHz	1/128 Hz [0.0078125 Hz]
65 kHz – 256 kHz	1/32 Hz [0.03125 Hz]
256 kHz – 1 MHz	1/8 Hz [0.125 Hz]
1 MHz – 4 MHz	1/2 Hz [0.5 Hz]
4 MHz – 10 MHz	2 Hz
Minimum Input Amplitude	200 mVpp
Nominal Input Impedance	
AES/EBU (XLR)	110 Ω or >5 k Ω
Video (BNC)	75 Ω or >5 k Ω
Square wave (BNC)	75 Ω or >5 k Ω
Lock Range	$\pm 0.0015\%$ [± 15 PPM]
Input Delay from Reference Display	Measures delay from 0 to 127.9 UI in seconds, ± 60 ns
Reference Rate Display	Measures approximate reference input rate

2.7.3 Reference Output Characteristics

A rear panel reference output is provided to drive devices under test that require their own reference input. The reference output signal is not jittered.

Output Format	AES/EBU (per AES 11-1994)
Output Sample Rates	28.8 kHz-100 kHz AES/EBU; locked to front panel output
Status Bits	Format "Professional" Sample Rate indicates closest rate Type "Grade 2 reference" Origin "SYS2" Reliability flags implemented CRCC implemented Time of Day not implemented Sample Count not implemented
Output Delay from Reference Output	-64/+63.5 UI, $\pm(5\% + 0.5$ UI), in 0.5 UI steps

Residual jitter	≤2 ns p-p (120Hz-100 kHz)
-----------------	---------------------------

2.8 Digital Analyzer

Available in the SYS-2500 and SYS-2522 configurations only.

2.8.1 Digital Input Characteristics

Input Formats	AES/EBU (per AES 3-1992) Dual Connector AES/EBU SPDIF-EIAJ Dual Connector SPDIF-EIAJ Optical (Toslink®) General purpose serial General purpose parallel Serial interface to chip level via optional SIA-2322 accessory
Sample Rates	28.8 kHz-100 kHz AES/EBU, 64 kHz - 200 kHz Dual Connector AES/EBU, 8 kHz - 200 kHz parallel, general purpose serial, SIA-2322; independent from output sample rate
Word Width	8 to 24 bits
Nominal Input impedance	
AES/EBU	110 Ω or ≥2.5 kΩ
SPDIF-EIAJ	75 Ω or ≥3 kΩ

2.8.2 Embedded Audio Measurements

2.8.2.1 Wideband Level/Amplitude

("ANALYZER.AZ2")

Range	0 dBFS to -140 dBFS
Frequency Range	<5Hz to 45.8% of sample rate 5 Hz to 20.2 kHz at 44.1 k samples/s 5 Hz to 22.0 kHz at 48 k samples/s 5 Hz to 44.0 kHz at 96 k samples/s
Accuracy	±0.01 dB, ≥-120 dBFS
Flatness	±0.01 dB, 15 Hz-22 kHz, with <10 Hz high-pass filter selection
High pass Filters	<10 Hz, 4-pole Butterworth 22 Hz, 4-pole Butterworth 100 Hz, 4-pole Butterworth 400 Hz, 4-pole Butterworth 400 Hz, 10-pole elliptical <i>when not using notch filter or bandpass mode</i> (response is -120 dB for ≤220 Hz, ±0.1 dB for ≥400 Hz)
Low pass Filters	20 kHz 6-pole elliptic low-pass 15 kHz, 6-pole elliptic low-pass

Weighting Filters	ANSI-IEC "A" weighting, Type 0 CCIR QPk per CCIR Rec 468 CCIR RMS per AES 17 C-message per IEEE Std 743-1978 CCITT per CCITT Rec. P.53 "F" weighting corresponding to 15 phon loudness contour (see Figure 2-29 on page 2-27)
Residual Noise	-140 dBFS unweighted -142 dBFS A-weighted -134 dBFS CCIR RMS -127 dBFS CCIR QPk -140 dBFS 20 kHz LP -140 dBFS 15 kHz LP -138 dBFS "F" weighting -150 dB CCITT -150 dB C Message

2.8.2.2 Narrow Band Amplitude

("ANALYZER.AZ2")

Frequency Range	<5Hz to 40% of sample rate 5 Hz to 17.6 kHz at 44.1 k samples/s 5 Hz to 19.2 kHz at 48 k samples/s 5 Hz to 38.4 kHz at 96 k samples/s
Filter Shape	10-pole, Q=19 (BW = 5.3% of f_o) (see Figure 2-30)
Residual Distortion	≤-150 dBFS

2.8.2.3 THD + N Measurements

("ANALYZER.AZ2")

Frequency Range	<5Hz to 45% of sample rate 5 Hz to 19.9 kHz at 44.1 k samples/s 5 Hz to 21.6 kHz at 48 k samples/s 5 Hz to 43.2 kHz at 96 k samples/s
Residual THD+N	≤-140 dBFS (see Figure 2-33)
High pass Filters	<10 Hz, 4-pole Butterworth 22 Hz, 4-pole Butterworth 100 Hz, 4-pole Butterworth 400 Hz, 4-pole Butterworth
Low pass Filters	20 kHz, 6-pole elliptic low-pass 15 kHz, 6-pole elliptic low-pass both: 0.1 dBpp ripple, ≥110 dB stopband attenuation
Weighting Filters	ANSI-IEC "A" weighting, Type 0 CCIR QPk per CCIR Rec 468 CCIR RMS per AES 17 C-message per IEEE Std 743-1978 CCITT per CCITT Rec. P.53 "F" weighting corresponding to 15 phon loudness contour (see Figure 2-29)
Residual Noise	Same as Wideband Level/Amplitude

2.8.2.4 Frequency Measurements

("ANALYZER.AZ2")

Range	5 Hz to 47% of sample rate (5 Hz - 21.0 kHz at 44.1 k samples/s) (5 Hz - 23.0 kHz at 48.0 k samples/s) (5 Hz - 46 kHz at 96 k samples/s)
Accuracy	±0.01% of reading or 0.0001% of sample rate, whichever is greater
Resolution	0.003% of reading or 0.0001% of sample rate, whichever is greater

2.8.2.5 FFT Spectrum Analyzer

(fft)

Acquisition Length	800 to 256 k samples in 11 steps
Transform Length	256-32768 samples in binary steps
Processing	48 bit
Windows (see Figure 2-27 and Figure 2-28)	Blackman-Harris (4 term with -92 dB sidelobe) Hann Flat-top (±0.02 dB) Equiripple (-145 dB sidelobes) None None, sync to sine Hamming Gaussian Rife-Vincent 4-term Rife-Vincent 5-term
Amplitude Accuracy	±0.02 dB, 20 Hz to 20 kHz, using Flat-top window
Averaging	1-4096 in binary steps, averaging algorithm is power based or synchronous
Distortion Products	≤-160 dB
Waveform Display Modes	Normal, interpolate, peak, max
Frequency Display Modes	Peak pick, individual bin
Sync to Sine Window	
Frequency Range	7 th bin to 45% of sample rate (21.6 kHz at 48 k samples/s)
Amplitude Accuracy	±0.025 dB
Spurious Products	≤-120 dB

2.8.2.6 Multi-Tone Audio Analyzer

(fasttest)

Acquisition Length	512-32768 samples in binary steps
Transform Length	512-32768 samples in binary steps
Processing	48 bit

Measurements	Level vs frequency, Total distortion vs frequency, Noise vs frequency, Phase vs frequency, Crosstalk vs frequency, Masking curve
Frequency Resolution	1.345 Hz with 44.1 k samples/s 1.465 Hz with 48.0 k samples/s 2.93 Hz with 96 kHz
Frequency Error Correction Range	±3%
Distortion	≤-140 dB

2.8.2.7 Quasi-Anechoic Acoustical Tester

(m/s)

Signals	Four pink sequences, four white sequences
Frequency Range	Sample rate/2000 to sample rate/2
Frequency Resolution (Max)	1.465 Hz at 48.0 k samples/s
Acquisition Length	32767 samples, 131071 samples, automatically selected between 32 k or 131 k sequence as furnished by generator
FFT Length	32768
Energy Time Windows	half Hann Hann <240 Hz >8 kHz <120 Hz >16 kHz
Time Windows (percent of data record to transition from 0 to full amplitude)	<5% <10% <20% <30%

2.8.3 Digital Interface Measurements

2.8.3.1 AES/EBU Impairments, real time displays

Input Sample Rate	±0.0003% [±3 ppm] internal ref, ±0.0001% [±1 ppm] external ref
Output to Input Delay	Measures status propagation from the AES/EBU output to the input. Range is 0-1 frame, resolution ±60 ns.
AES/EBU Input Voltage	
XLR	100 mV to 10.24 V _{pp} , ±(5% + 50 mV)
BNC	25 mV to 2.048 V _{pp} , ±(5% + 12 mV)
Jitter Amplitude	(peak calibrated at 500 Hz)
50-100kHz BW	0-3.00 UI, ±(10% + 0.01 UI)
other BW selections	0-1.00 UI, ±(10% + 0.005 UI)
Jitter Flatness ²²	±1 dB, 100 Hz – 20 kHz

²² 50 Hz-100 kHz BW selection using Avg detector. Specification applies at 32.0, 44.1, 48.0, 64.0, 88.2, and 96.0 ks/s only. Flatness may be degraded at other sample rates.

Residual Jitter ²³	
48 ks/s	≤0.010 UI [1.6 ns]
96 ks/s	≤0.020 UI [1.6 ns]
Jitter Spectrum	Spurious products are typically <0.0003 UI [-70 dBUI] or 40 dB below jitter signal, whichever is larger
Common Mode Ampl	0-20.48 Vpp, ±(10%+300 mV), 315 Hz-200 kHz
Common Mode Amplitude	0-20.48 Vpp, ±(10% + 300 mV), 315 Hz-1 MHz, peak reading
Cable Equalization	Per AES 3-1992
Channel Status Bits	Full implementation, English language decoded (Professional or Consumer) or hex formats, independent in each channel
User Bits	Not displayed
Validity Flag	Displayed for each channel
Parity	Displayed for total signal (both channels combined)
Signal Confidence	Displayed for total signal (both channels combined)
Receiver Lock	Displayed for total signal (both channels combined)
Coding Error	Displayed for total signal (both channels combined)

2.8.4 Digital Interface Analyzer

(intervu)

INTERVU operates in conjunction with an autoranged 8-bit A/D converter clocked at 80.0 MHz, providing interface signal measurements with >20 MHz bandwidth. INTERVU can display the interface signal in time or frequency domain, as an eye pattern, or probability graphs of amplitude or pulse width. INTERVU also can demodulate the jitter signal and display it in time or frequency domain or as a probability graph. The jitter signal or the data on the interface may be reproduced through the monitor loudspeaker.

AES/EBU Input Voltage	
Balanced	0 – 20.48 Vpp, ±(10% + 50 mV)
Unbalanced	0 – 4.096 Vpp, ±(8% + 12 mV)
Jitter Amplitude	0 – 5 UI pk, ±(5% + 0.015 UI)
Residual Jitter	≤0.01 UI (50 Hz – 1 MHz BW)
Spurious Jitter Products	≤0.001 UI, or ≤-60 dB below jitter signal
Common Mode Amplitude	0 – 20.48 Vpp, ±(30% + 50 mV), 20 kHz – 1 MHz
Jitter Probability Display	256 bins, autoranging
Input Probability Display	256 bins, autoranging
Bit Width Probability Display	8192 bins
Risetime	≤20 ns
Acquisition time/memory	19.66 ms / 1,572,864 samples

²³ System specification including generator contribution. The following conditions must be met: (1) the jitter generator amplitude must be turned off or set for 0.0000 UI, (2) all other forms of impairment must be off or disabled, and (3) the digital input must be ≥1.0 Vpp (XLR) or ≥250 mVpp (BNC).

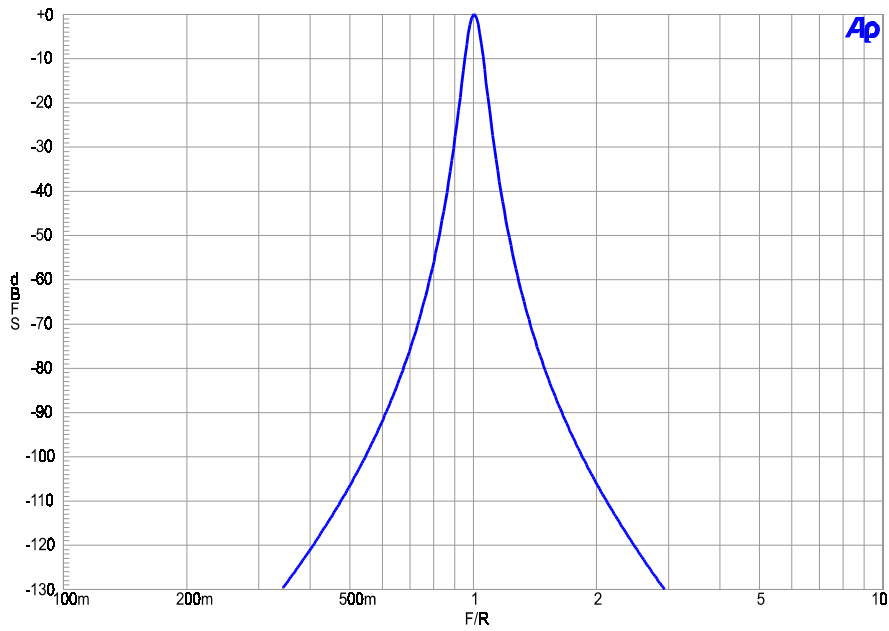

Figure 2-32. Digital Domain Band Pass filter response

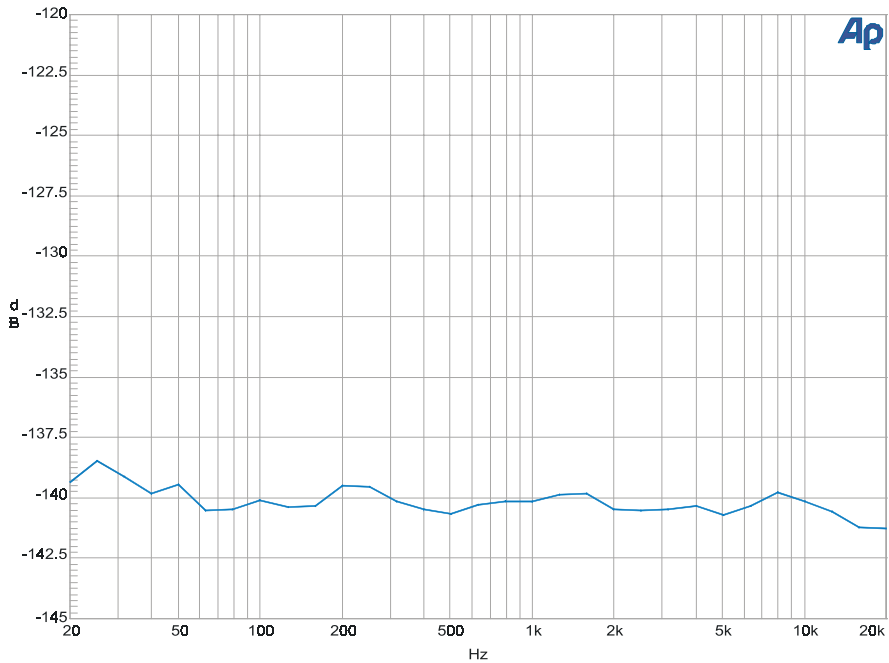

Figure 2-33. Typical Digital Domain system residual THD+N

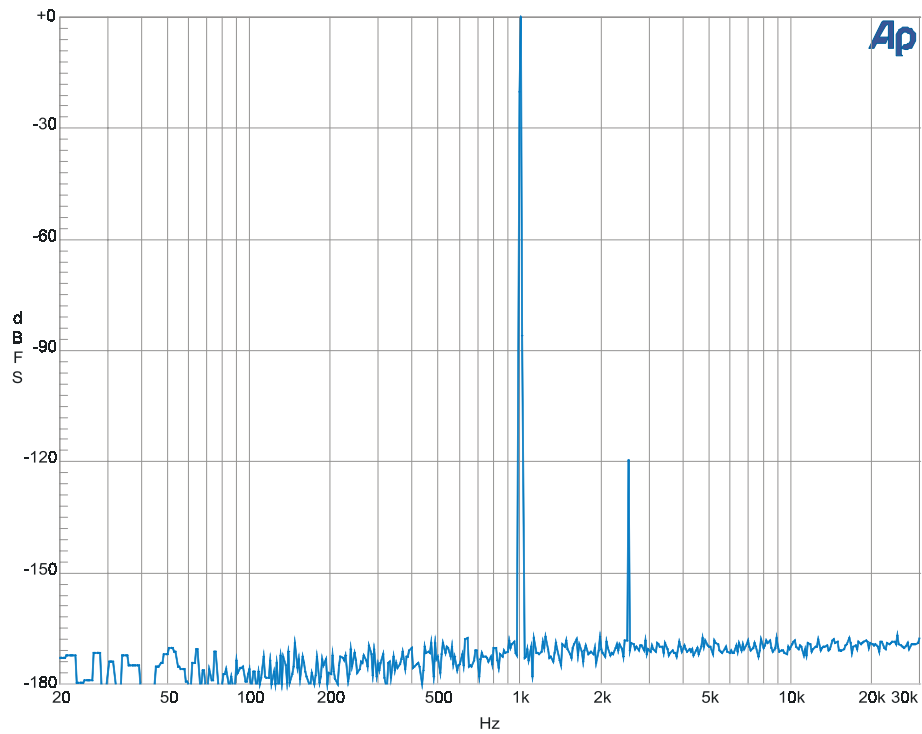

Figure 2-34. Illustration of typical Digital Domain FFT dynamic range. Signal is 0 dB 1 kHz with a secondary signal at -120 dB and 2.5 kHz. Harmonics of 1 kHz signal are visible below -165 dB, consistent with 24-bit audio.

2.9 Auxiliary Signals

2.9.1 Generator Signal Monitors

(all units except SYS-2500)

Channel A	Buffered version of the channel A analog generator signal. Amplitude is typically 2.8 Vpp.
Channel B	Buffered version of the channel B analog generator signal. Amplitude is typically 2.8 Vpp.

2.9.2 Generator Auxiliary Signals

(all units except SYS-2500)

Sync Output	LSTTL compatible signal that is intended to be used as a trigger for stable oscilloscope displays.
Trig/Gate Input	LSTTL compatible input, functional with option "BUR" only.

2.9.3 Analyzer Signal Monitors

(all units except SYS-2500)

Channel A	Buffered version of the channel A analog input signal. Amplitude is typically 0 – 3.6 Vpp.
Channel B	Buffered version of the channel B analog input signal. Amplitude is typically 0 – 3.6 Vpp.
Reading	Buffered version of the analog analyzer output signal after all filtering and gain stages. Amplitude is typically 0 – 3.6 Vpp.

2.9.4 Digital Signal Monitors

(SYS-2422 & SYS-2522 only)

Via stereo 16-bit D/A converters. Function monitored depends upon analyzer program loaded; for example, noise and distortion products after notch filter are monitored with DSP Audio Analyzer in its THD+N function.

Channel 1	Buffered version of the digital channel 1 signal.
Channel 2	Buffered version of the digital channel 2 signal.

2.9.5 Digital Interface Monitors

(SYS-2522 & SYS-2500 only)

Transmit Frame Sync	Squarewave at the programmed internal sample rate
Receive Frame Sync	Squarewave at the rate of the received AES/EBU signal
Master Clock Out	Squarewave at 256 x the programmed output sample rate. Selectable between jittered andunjittered signals.

2.9.6 Miscellaneous Digital I/O

(SYS-2500 & SYS-2522 only)

Auxiliary Input	LSTTL compatible trigger input for dsp program data acquisition.
Auxiliary Output	HCMOS signal, function under dsp program control.
Trigger Output	HCMOS signal, pulse coincident with period of generated signal waveform.

2.10 Audio Monitor

All System Two Cascade configurations contain an internal loudspeaker and headphone jack for listening to the generator, analyzer, or digital signal monitor points described above, including noise and distortion following analog or digital notch filters or the AES/EBU jitter signal. Use of the audio monitor does not preclude the use of any measurements.

Power Output Typically 1 Watt

2.11 Primary Power and Fuse Information

Refer to Section 3.2 for instructions on selecting primary input voltage range, replacing fuses, and changing fuse types.

Primary Voltage Ranges, all components	100, 120, 230, or 240 V ac (-10%/+6%), 50 - 60 Hz	
Power Ratings	240 VA max	
Fuse Requirements	100 or 120 V 2 A	230 or 240 V 1 A

2.12 Environmental

Temperature Range	
Operating	+5°C to +40°C
Storage	-40°C to +75°C
Humidity	80% RH to at least +40°C (non-condensing)
Altitude	2000 m Maximum

2.13 Physical Dimensions and Weights

Dimensions	
Width	17.5 in. (44.4 cm), including handle and feet
Height	5.7 in. (14.5 cm), including feet
Depth	18 in. (45.7 cm), including connectors
Weight	Approximately 34 lbs [15.9 kg], depending upon options installed

2.14 Regulatory Compliances

EMC ²⁴	Complies with FCC Part 15 Subpart J (class B), 89/336/EEC, 92/31/EEC, and 93/68/EEC, EN 50081-1 (1992) Emissions Class B, EN-50082-1 (1992) Immunity
Safety	Complies with 73/23/EEC, 93/68/EEC, EN6010-1 (1993) – IEC 1010-1 (1990) + Amendment 1 (1992) + Amendment 2 (1995) Installation category II – Pollution Degree 2

2.15 Software and Control

2.15.1 Computer Requirements

Note: Beginning with version 1.6, APWIN operates only under Windows 95, Windows 98, or Windows NT 4.0 (or later). APWIN operation under Windows 3.xx is no longer supported.

The decision of what kind of computer to use to host APWIN is a complex one. Minimum performance requirements are dictated first by the operating system. APWIN is a Microsoft Windows-based program; as such, it requires that Windows 95, Windows 98, or Windows NT 4.0 (or later) be installed on the computer. Windows, in turn, has its own hardware and software requirements. Although there is a minimum configuration that will run Windows 95, practical considerations suggest a configuration exceeding this to achieve acceptable speed with most applications, including APWIN. The following table lists the minimum, recommended, and optimal requirements. These guidelines assume APWIN is the dominant application.

- *Minimum Requirement* is a list of main features to be used to qualify an existing machine as able to provide acceptable performance.
- *Recommended Configuration* defines a minimum set of cost-effective features to be specified when purchasing a new machine.
- *Optimal Configuration* defines an ideal configuration to achieve the best performance and speed.

²⁴ Emission and Immunity levels are influenced by the shielding performance of the connecting cables. The shielding performance of the cable will depend on the internal design of the cable, connector quality, and the assembly methods used. EMC compliance was evaluated using Audio Precision XLR type cables, part number 4155.0117.

These requirements may be affected by what other software needs to run on the same machine and if this software needs to run at the same time as APWIN.

Hard drive sizes have been specified based somewhat on practical commercial availability. Although a 500-MB hard drive should be adequate to host Windows 95 and APWIN, as of this writing nothing less than about 2 GB is commonly available and the cost difference between a 2-GB and an 8-GB drive is less than 10% the cost of the complete computer. This suggests that the larger size makes more economic sense.

Hardware	Minimum requirement	Recommended configuration	Optimal configuration
CPU type	486 DX-2 or DX-4	Pentium, K6, Cyrix 6x86	Pentium II, K6-2, or Celeron
CPU speed	66MHz or 100 MHz	150 MHz to 300 MHz	300 to 400 MHz
RAM memory	16 MB	32 MB	64 to 128 MB
Hard Drive size	500 MB	4 GB	6 to 8 GB
Free hard drive space	100 MB	100 MB	100 MB
Graphic card ram	1 MB	2 to 4 MB	8 MB
Video resolution	640 x 480	1024 x 768	1024 x 768
Monitor	14"	15"	17"

2.15.2 ISA-WIN APIB Card

The ISA-WIN APIB Card is installed in the user's pc and interfaces between the PC and the APIB (Audio Precision Interface Bus). The ISA-WIN card is a half-size, 8-bit card and includes jumpers to set the computer address and an APIB cable to connect to the first device. Refer to Section 3.3 for further information.

2.15.3 PCM-WIN Card

The PCM-WIN Card interfaces between a portable computer and the APIB. The computer must have a Type II PCMCIA slot and, if running Windows 3.11, be version 2 or greater software compliant and have Card and Socket Services release 2.1 or later software installed. Refer to Section 3.4 for further information.

2.15.4 Cables and Adapters

2.15.4.1 Analog Audio Cables

These cables provide a convenient method to connect Audio Precision measurement equipment with a device under test. These cable kits consist of four cables, each with a unique color band at the connector ends to facilitate identification. The cables are high quality Mogami NEGLEX super flexible shielded cable, and are 8 ft (2.4 m) long. The cables and connector shells are satin black, and all connectors have gold plated contacts.

- CAB-XMF consists of a set of four XLR male to XLR female cables.
- CAB-XBR consists of a set of four cables with XLR male connectors to RCA/PHONO male connectors. Also provided are four adapters, from RCA female to BNC male. The cables are wired with pin 2 of the XLR connector as “hot” (center pin of the RCA connector) and pins 1 and 3 connected to ground and shield, to agree with the unbalanced wiring convention of Audio Precision instruments. See Figure 2-35 and Figure 2-36.



Figure 2-35. CAB-XBR cable kit

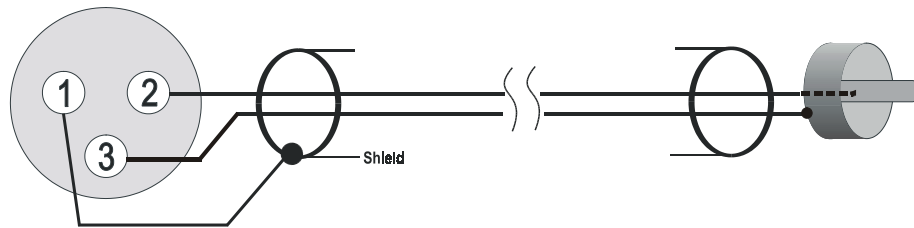

Figure 2-36. XLR to BNC wiring

2.15.4.2 Digital Audio Cables

These cables are designed to meet CE EMI emission requirements.

- CAB-AES: Set of two AES/EBU cables, 39 in. (1 m) long. See Figure 2-37.
- CAB-AES2: Set of two AES/EBU cables, 6.5 ft (2 m) long.
- CAB-AES4: Set of two AES/EBU cables, 13 ft (4 m) long.



Figure 2-37. CAB-AES cable set

- CAB-DIO: Set of two interface cables, 4.25 ft (1.3 m) long, to connect between the SYS-2522 rear panel 50-pin ribbon input/output connectors to a DUT fixture with 0.1-in. spaced 2 x 25-pin headers. See Figure 2-38.



Figure 2-38. CAB-DIO Cables

2.15.4.3 Cable Adapters

- CAD-RCA: set of 14 RCA/Phono female to BNC male adapters, intended primarily for use with the SWR-2122U Unbalanced Switcher.

2.15.4.4 Digital Control (APIB) Cables

These cables can be used as extensions or replacements for the APIB cables that come with each instrument or ISA APIB controller card.

- CAB-D0: Extension APIB Interface cable, 20 in. (0.5 m).
- CAB-D2: Extension APIB Interface cable, 6.5 ft. (2 m).
- CAB-D6: Extension APIB Interface cable, 12.7 ft. (6 m).

3. Hardware Installation

Hardware setup involves installing an interface card in the computer and connecting a cable from this interface card to the System Two Cascade. Every copy of APWIN comes with an ISA-bus half-size interface card or, as a option, a PCMCIA interface card. One of these cards is required for APWIN to communicate with System Two Cascade. (Earlier Audio Precision PCI-1, PCI-2, or PCI-3 cards or current ISA-DOS or PCM-DOS interface cards will not work with APWIN.)

For table top use, the System Two Cascade can be stacked with switchers or other instruments.

3.1 Rack Mounting

There are two styles of rackmount kits available to rack mount the System Two Cascade: fixed, and slide-out.

3.1.1 Fixed Rack-Mounting Brackets

Install the fixed installation rackmounting kit as shown in Figure 3-1. The parts required are identified in Table 3-1.

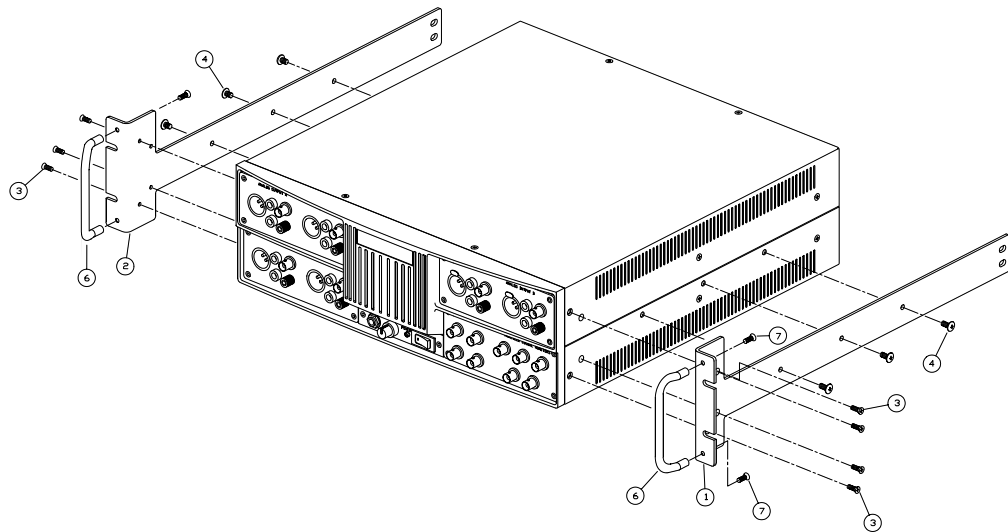

Figure 3-1. Fixed installation rackmounting kit

Table 3-1. Parts list for fixed installation rackmounting

ITEM	A-P NUMBER	DESCRIPTION
-1	7170.XXXX	RACK EAR BRACKET, RH
-2	7170.XXXX	RACK EAR BRACKET, LH
-3	5113.1110.6	SCREW #6-32X5/16 MC FLT PH DGY
-4		SCREW #10-32X3/8 MC TRUSS PH DGY
-6	7320.0006	HANDLE
-7	5114.1108	SCREW MC FLT PH ZN #8-32X1/4

3.1.2 Sliding Rack-Mounting Brackets

The slide rackmounting kit is intended to be used with Chassis Track C-300-S Series non-pivoting solid bearing chassis sections from General Devices Inc, Indianapolis, IN. These chassis sections are available in several lengths to fit a wide variety of racks.

Install the sliding installation rackmounting kit as shown in Figure 3-1. The parts required are identified in Table 3-1.

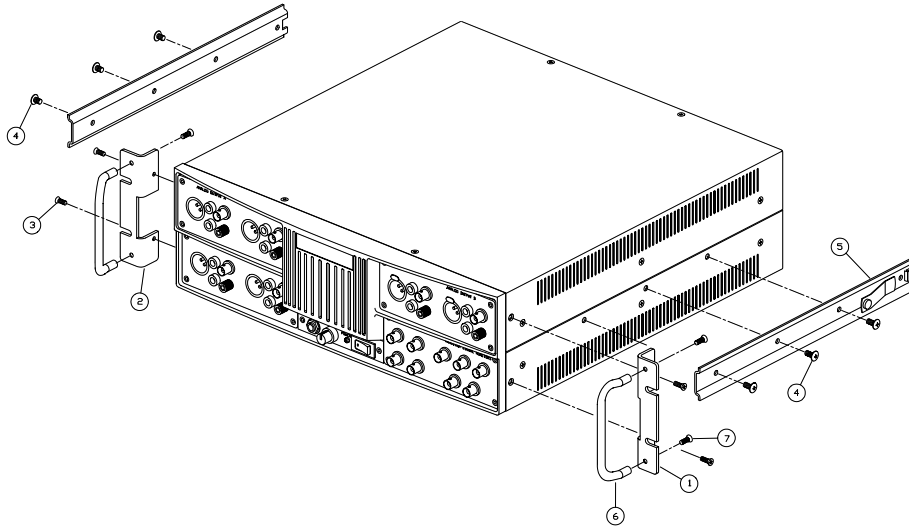

Figure 3-2. Sliding rack mount installation kit

Table 3-2. Parts list for sliding installation rackmounting

ITEM	A-P NUMBER	DESCRIPTION
-1	7170.0202	RACK EAR BRACKET, RH
-2	7170.0201	RACK EAR BRACKET, LH
-3	5113.1110.6	SCREW #6-32X5/16 MC FLT PH DGY
-4		SCREW #10-32X5/16 MC TRUSS PH DGY
-5		SLIDE - STATIONARY SECTION
-6	7320.0006	HANDLE
-7	5114.1108	SCREW MC FLT PH ZN #8-32X1/4

3.1.3 Rackmounting the Switchers, SIA-2322, and DCX-127

To rack mount the switchers, SIA-2322, and DCX-127, note that the rackmounting brackets can be installed in two ways:

- To mount the front panels flush with the front of the rack, or
- To mount the instruments with the panels recessed, which allows space for the connectors inside the rack.

For the switchers, be sure to observe the instruction given in Section 3.2.1 when rackmounting.

3.2 Primary Power Considerations

Refer to fuse specifications on the rear-panel label for all power line-powered instruments. Unplug the power cord from the instrument before changing fuses or performing any other operations described in this section.

3.2.1 AC Mains Switch Required

The SWR-2122-Series switchers do not have individual power switches and are intended for continuous operation. However, they should be plugged into a switched power source or mounted to give the user access to the mains cable for disconnect.

3.2.2 Checking or Changing Power Line Voltage

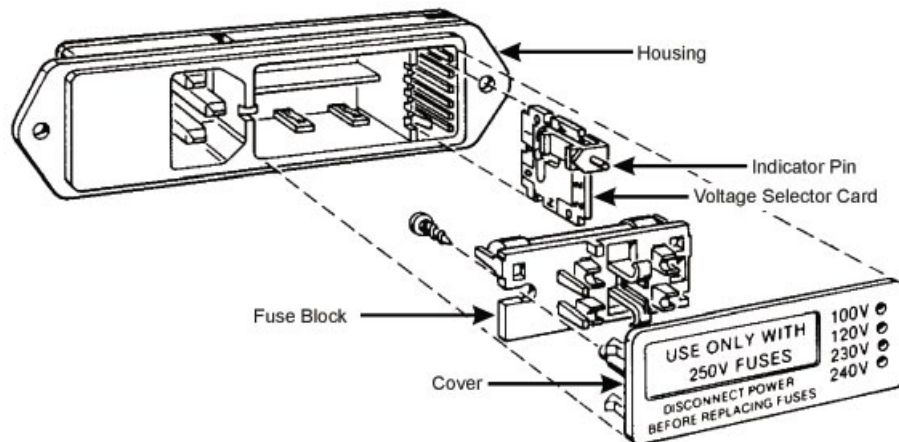

Figure 3-3. Changing power line voltage

The AC Mains input to each instrument is made through a connector/fuse block/voltage selector assembly. Before connecting the power cord, confirm that the input voltage selection is correct for your power source. An indicator pin shows the selected input voltage in one of the four holes in the cover (see Figure 3-3).

To change the input voltage, refer to Figure 3-3 and proceed as follows:

1. Remove the AC power cord from the AC Mains Connector.
2. Open the cover, using a small blade screwdriver or similar tool. Set aside the cover/fuse block assembly.
3. Pull the voltage selector card straight out of the housing, using the indicator pin.

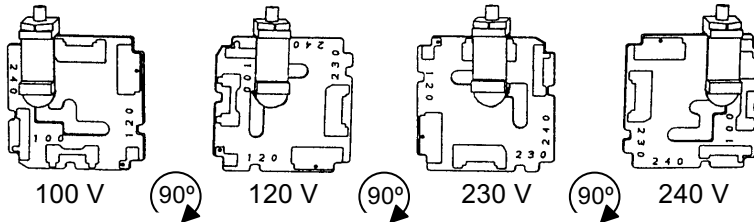

Figure 3-4. Voltage selector card positions

4. Orient the selector card so that the desired input voltage is readable at the bottom (see Figure 3-4). Then orient the indicator pin to point up when the desired voltage is readable at the bottom, with the indicator pin assembly seated in the notch on the board edge.
5. Insert the voltage selector card into the housing with the printed side of the card facing toward the connector, and the edge indicating the desired voltage first.
6. Confirm that the correct fuse is installed for the intended input voltage (refer to fuse ratings marked on the rear panel). If necessary, change the fuse type as described in the following section.
7. Replace the cover and verify that the indicator pin shows the desired voltage.

3.2.3 Fuse Information

The connector/fuse block/voltage selector assembly allows two fusing arrangements: North American (see Figure 3-5), and European (see Figure 3-6). The North American fusing arrangement uses a single type 3AG (0.25 x 1.25 in.) SB (“slow blow”) fuse; the European fusing arrangement uses two 5 x 20 mm IEC-approved type T fuses. Refer to the label on the rear panel for fuse current ratings.

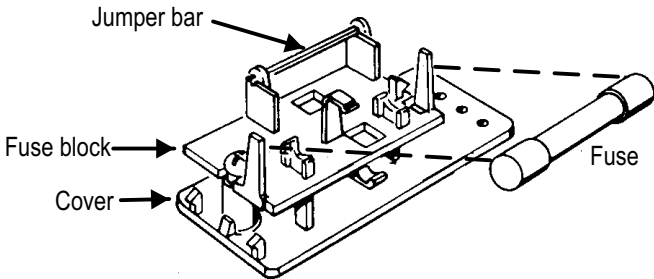

Figure 3-5. North American fusing arrangement

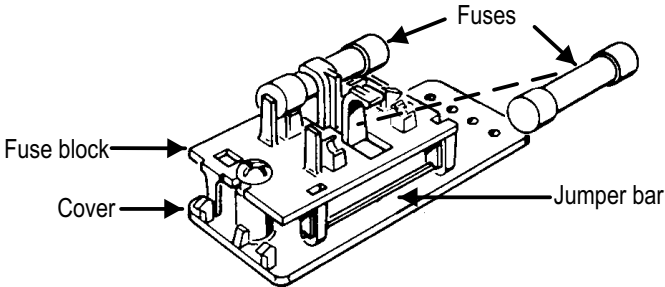

Figure 3-6. European fusing arrangement

3.2.4 Changing Fusing Arrangement

To change from one fusing arrangement to the other:

1. Remove the AC power cord from the AC Mains Connector.
2. Open the cover of the connector/fuse block/voltage selector assembly with a small blade screwdriver or similar tool.
3. On the back of the cover, loosen the Phillips screw two turns, then remove the fuse block by sliding up, then away from the screw and lifting from pedestal at the other end (refer to Figure 3-7).

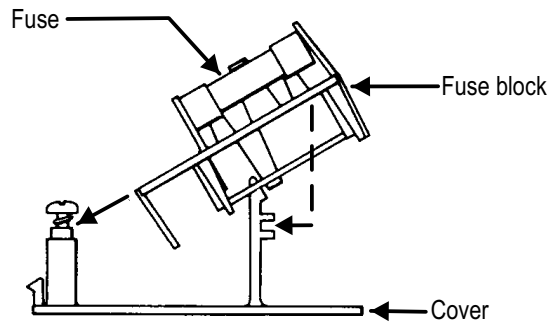

Figure 3-7. Changing fuse types

4. Invert the fuse holder and reassemble it on the Phillips screw and pedestal, and tighten the screw.
5. Change or add the correct fuses as necessary (again, refer to rear panel for the correct fuse current rating).
6. Confirm the line voltage setting as described in the previous section, then replace the cover.

3.2.5 Proper Environment

All Audio Precision System One, System Two, and System Two Cascade products are intended for use indoors, in a normal environment. Refer to Section 2.12 for temperature range and humidity specifications.

3.3 Installing ISA-WIN APIB Card

The ISA-WIN card, shown in Figure 3-8, is a half size (8-bit) card that must be installed in the host PC to interface the ISA Bus in the PC to the APIB. Included with the card is an APIB interconnecting cable.

Alternatively, a PCMCIA interface card is available for use with laptop computers. See Section 3.4.

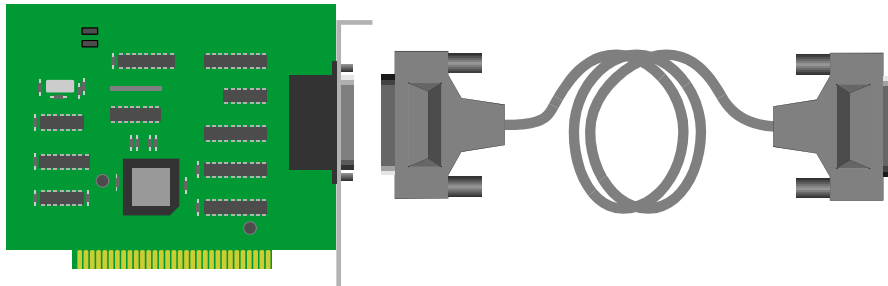

Figure 3-8. ISA-WIN Interface Card and cable

TIP:

Whenever handling electronic components such as this interface card, it is necessary to avoid static electricity discharge that can permanently damage the card. Always leave the card in the protective static bag prior to actual insertion. Before picking up the card to install it in the computer, drain any static charge in your body by touching the chassis of the computer. Pick up the card by the metal bracket and avoid touching any of the components on the card. The “snap” discharge you may notice when you touch a metal object after walking across a carpet can be several thousand Volts (although at a very low current) and can do catastrophic damage to unprotected integrated circuits such as those on this interface card.

Disconnect the power to the computer, remove the cover and install the card in an unused slot. Be sure the card is well seated; it should snap down into the connector of the mother board of the computer. Install the hold-down screw on the card bracket and replace the cover.

3.3.1 Address Jumper Settings

You will notice two jumpers near the top edge of the card. In most cases, these will not have to be changed. They define the address location of the card and can be used to change the default address if conflicts arise. Unless you know of a conflict, leave the jumpers in the factory default position. After installation, if conflicts arise, these jumpers can be changed to define an alternate location. To change jumpers, turn off power to the computer, remove the cover and remove the card. Use caution handling the card to avoid static discharge. Refer to Figure 3-9 and set the jumpers to an alternate location. Replace the card and cover.

Address Location	J202	J201	Notes
238	Removed	Installed	
298	Installed	Installed	
2b8	Installed	Removed	Factory Default
2d8	Removed	Removed	

(Memory space required: eight address locations.)

Note:
 When APWIN starts, it will automatically look through the possible address locations to find an ISA-WIN or PCM-WIN card. In the unlikely event that this auto-detect does not function correctly, you can force the software to utilize a specific address location using command line start-up switches. To do this, see Section 5.1.1.

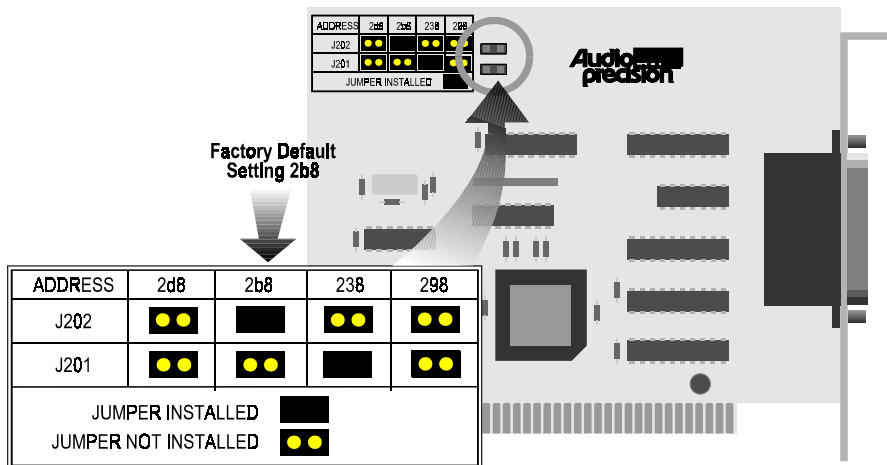

Figure 3-9. ISA-WIN APIB Card with address jumper selections shown

3.4 Installing PCM-WIN PCMCIA Interface Card

The Audio Precision PCM-WIN card is a PCMCIA to APIB interface adapter. It can be used to connect a PC or notebook computer equipped with a PCMCIA type II slot and version 2.1 or later Card and Socket Services to Audio Precision instruments via the Audio Precision Interface Bus (APIB). It functions the same as the ISA-WIN interface card that is used with ISA bus PCs.

Note:

If you are using the PCM-WIN card, do NOT install it until after the APWIN software is installed, per Section 4.

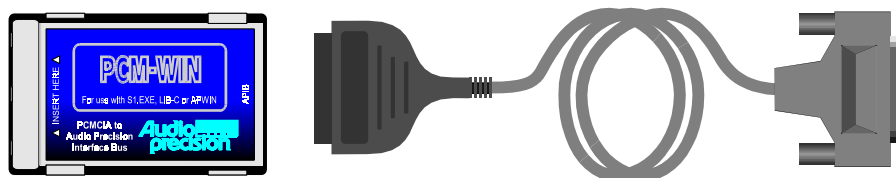

Figure 3-10. PCMCIA to APIB interface card and cable

Refer to Section 4.1 to install the associated PCMCIA drivers.

3.5 Connecting the APIB Interface

Simply connect the cable from the APIB Interface card in the PC to the System Two Cascade. If your system includes switchers, notice that each SWR-2122 switcher has two APIB connectors on its rear panel. This permits connecting them in a “daisy-chain” fashion between the computer’s APIB card connector and the System Two Cascade APIB connector (see Figure 3-11). The switcher’s connectors pass the APIB lines through, and the switchers respond only when specifically addressed, as described below. Normally, the computer will be connected to the first switcher with a digital interface cable, the first switcher connects to the second, etc, and the last switcher connects to the System Two Cascade digital interface (APIB) connector.

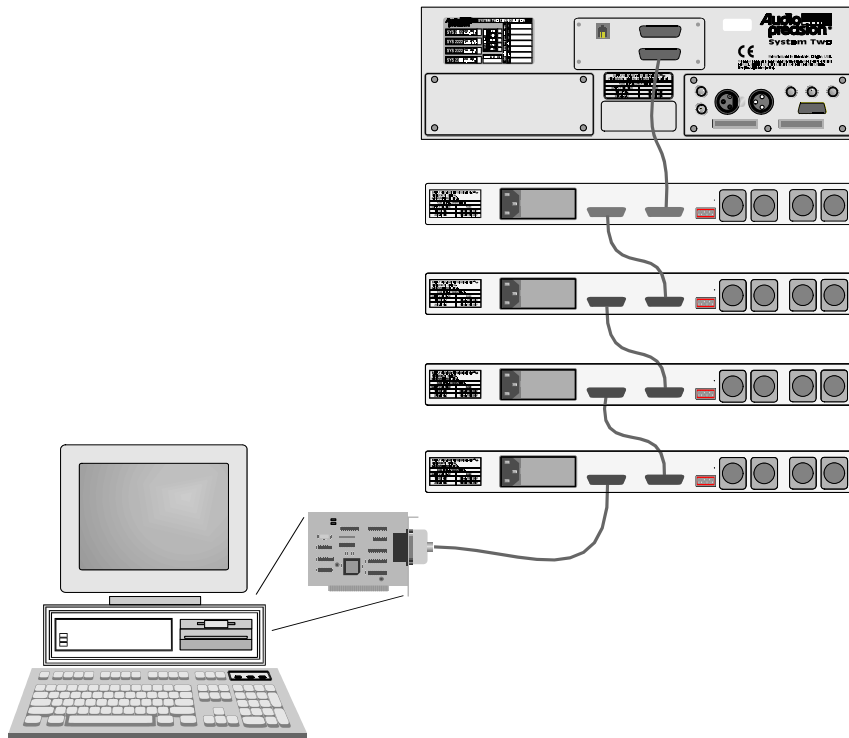

Figure 3-11. APIB connections block diagram (typical)

3.6 Setting Switcher Addresses and Modes

A six-switch binary switch bank is located on the rear panel. The first four switches on this bank select which group of channel numbers the module responds to as described in Table 3-3. The last two switches function as described in the appropriate subsection below.

These switches are marked 1 through 6 on the switch itself; on the panel, the first four are labeled 1, 2, 4, and 8, which corresponds to their bit value in the address word. The up, or ON, position corresponds to a logic 0 (low).

Input, Output, and patch point switchers may all be combined in the same system. Input and output switchers may share the same addresses. A patch point switcher must not have the same addresses as either an input or output switcher. Two patch point switchers may be set to the same address if one is set as Channel A and the other as Channel B (see Section 3.6.2).

3.6.1 Switcher Address Settings

Each switcher module consists of 12 channels. Up to 16 modules may be stacked to provide up to 192 channels. Rear panel address switches must be set to select to which channel commands from the software each switcher module should respond. For example, the first switcher is normally set to channels 1-12, the second module to channels 13-24, etc.

Figure 3-12 shows a typical rear-panel APIB Address switch. Table 3-3 shows relationships among APIB Address switch positions, binary codes, and channel numbers on the APWIN software “panels.”

Table 3-3. APIB Address switch settings

Channel Numbers	Rear Switch Settings				Binary Code
	8 (Switch 4)	4 (Switch 3)	2 (Switch 2)	1 (Switch 1)	
1 – 12	Up	Up	Up	Up	0000
13 – 24	Up	Up	Up	Down	0001
25 – 36	Up	Up	Down	Up	0010
37 - 48	Up	Up	Down	Down	0011
49 - 60	Up	Down	Up	Up	0100
61 - 72	Up	Down	Up	Down	0101
73 - 84	Up	Down	Down	Up	0110
85 - 96	Up	Down	Down	Down	0111
97 - 108	Down	Up	Up	Up	1000
109 - 120	Down	Up	Up	Down	1001
121 - 132	Down	Up	Down	Up	1010
133 - 144	Down	Up	Down	Down	1011
145 - 156	Down	Down	Up	Up	1100
157 - 168	Down	Down	Up	Down	1101
169 - 180	Down	Down	Down	Up	1110
181 - 196	Down	Down	Down	Down	1111

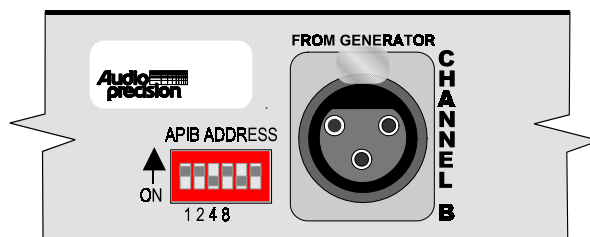

Figure 3-12. Rear panel DIP switch (typical)

3.6.2 Input, Output, and Patch Point Switcher Mode Switches

Switches 5 and 6 of the switch bank set the switcher mode as described in Table 3-4. The modes are defined below.

Table 3-4. Switcher mode settings

Input, Output Mode	Rear Switch	
	Switch 5	Switch 6
Either A or B*	Up	Up
Channel A	Down	Up
Channel B	Up	Down
Off	Down	Down

***Either A or B:** This mode is valid only for Input and Output switchers. The switcher's channel A responds to the A channel addresses, and channel B responds to B channel addresses. This is the normal mode.

Channel A: The switcher's channel A and channel B both respond to A channel addresses.

Channel B: The switcher's channel A and channel B both respond to B channel addresses.

Off: Neither channel responds to any address.

3.6.3 Unbalanced Switcher Mode Switch

The SWR-2122U unbalanced switcher may be used for generator output or analyzer input switching. Switch 6 of the six-switch binary switch bank selects between these modes:

Set Switch 6 to the UP position to operate as an input switcher (switcher will use Input switch channel numbers for Channel A and Channel B on A Channel and B Channel addresses).

Set Switch 6 to the DOWN position to operate as an output switcher (switcher will use Output switch channel numbers for Channel A and Channel B on A Channel and B Channel addresses).

Switch 5 disables the switcher; in the DOWN position, the switcher will not respond to any addresses.

Also note the labeling on the rear panel describing the difference in cable connections to the four rear-panel BNCs when used as an input versus output switcher. See Figure 3-13.

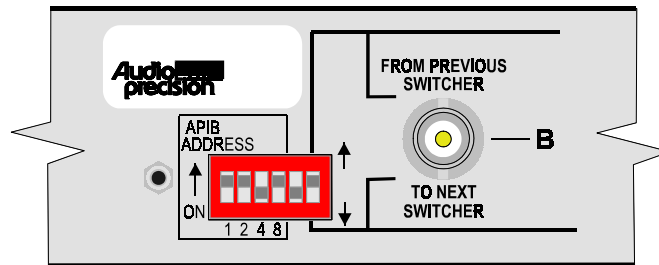

Figure 3-13. Unbalanced switcher address/mode switch

3.6.4 Switcher Circuit Board Jumpers

Remove the AC power cord from the AC Mains Connector before removing the cover to inspect or change the jumper settings.

A common circuit board design is used in all models of the switchers. Two jumpers on the circuit board, marked P62 and P63, select whether the switcher functions as an input switcher, output switcher, unbalanced switcher, or patch point switcher. These jumpers are shown in Figure 3-14. The jumper positions are shown for reference only and will normally not need to be changed.

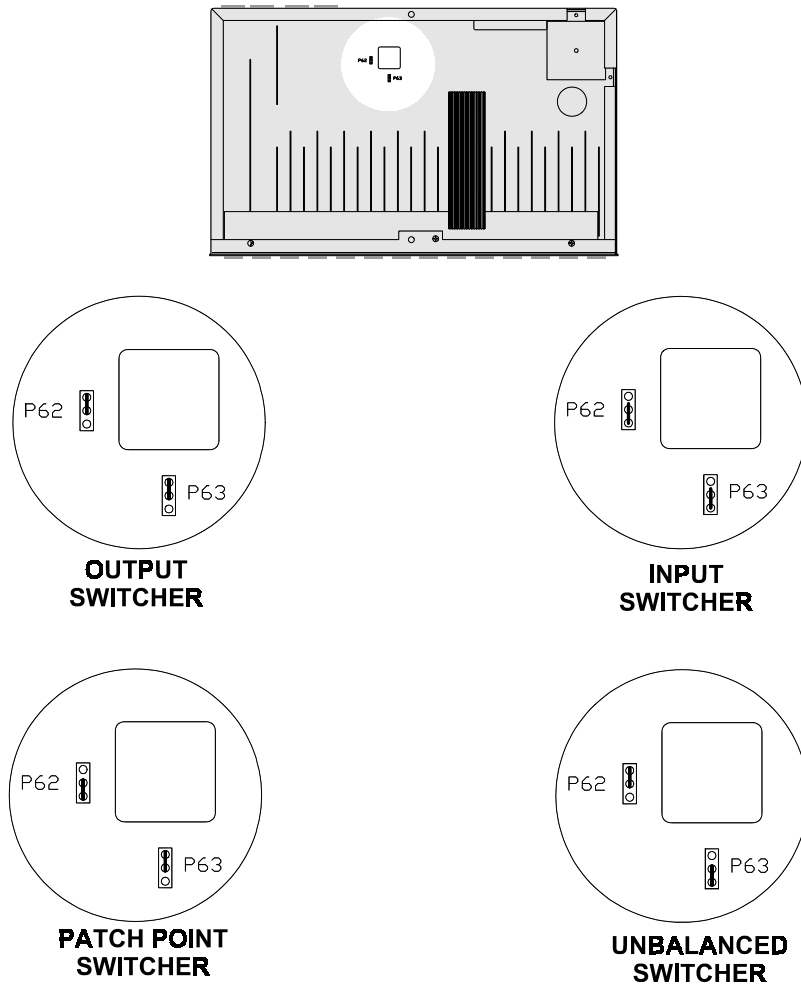

Figure 3-14. Switcher mode jumper positions

4. Software Installation– Windows 95, 98, and NT

APWIN comes with an easy to use setup utility that will perform the complete installation. All options and system dependent variances are handled automatically.

APWIN uses the standard Windows Notepad or Wordpad program for its error reporting file. Notepad and Wordpad are automatically installed when you install Windows but if you have removed them for some reason, you must reinstall one of these editor programs to be able to use the error file feature of APWIN.

Note:

APWIN will run in any video resolution supported by Windows including 640 x 480, 800 x 600, 1024 x 768, and 1280 x 1024. If your system has the capability, we find that the 1024 x 768 resolution gives the best visual presentation and functionality.

To begin APWIN installation, insert the CD-ROM (or diskette 1) into the appropriate drive. If your CD-ROM's Autostartup feature is enabled, you should see the screen shown in Figure 4-1. Otherwise, from Windows Explorer, browse to the file SETUP.EXE in the disk's root directory, and double-click.

Note:

If your system is to be controlled via a PCM-WIN card, do NOT install the card until AFTER the APWIN software is installed (the ISA-WIN card can be installed either before or after the following APWIN installation).



Figure 4-1. APWIN installation Setup screen

Click on the **Install APWIN 1.6** button. If you are installing under Windows NT 4.0, your account must have Administrator rights. Otherwise, you will get the following screen (Figure 4-2) when you try to install:

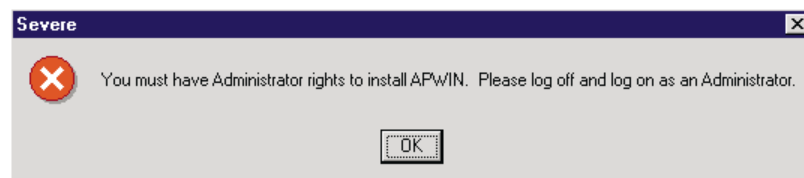

Figure 4-2. Windows NT Administrator rights warning screen

The following screen appears (Figure 4-3):

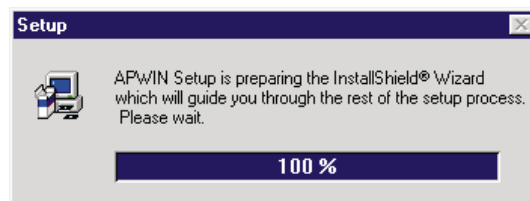

Figure 4-3. Setup progression screen

After the setup progression screen completes, you should see the Welcome screen of Figure 4-4:

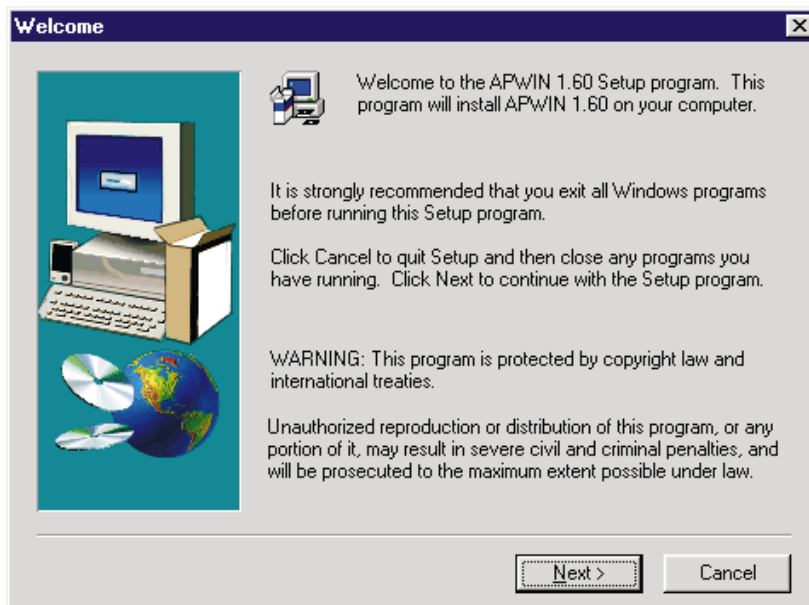



Figure 4-4. Welcome screen

Click the  button. The following dialog box appears:

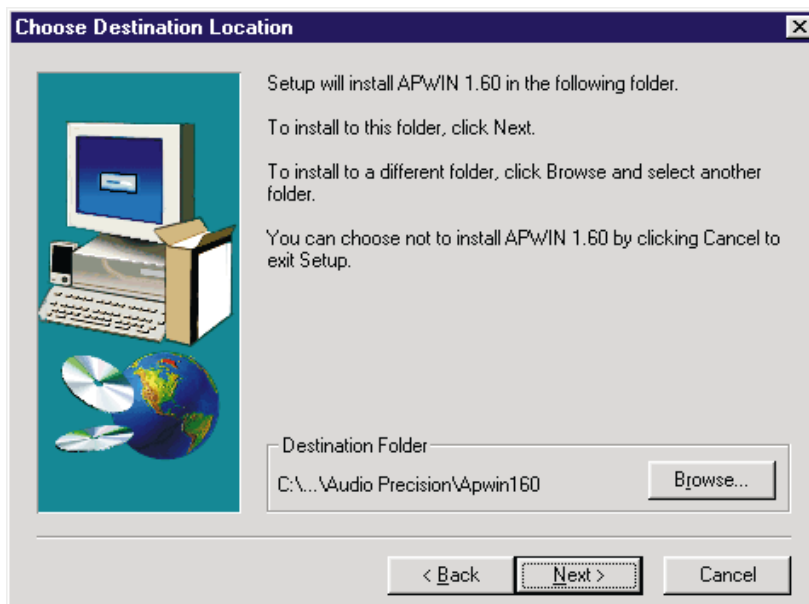

Figure 4-5. Choose Destination Location for APWIN dialog box

This screen (Figure 4-5) will suggest location for the APWIN program files. If you wish to choose an alternate location, click on the button. When you click the button, the dialog shown in Figure 4-6 will appear.

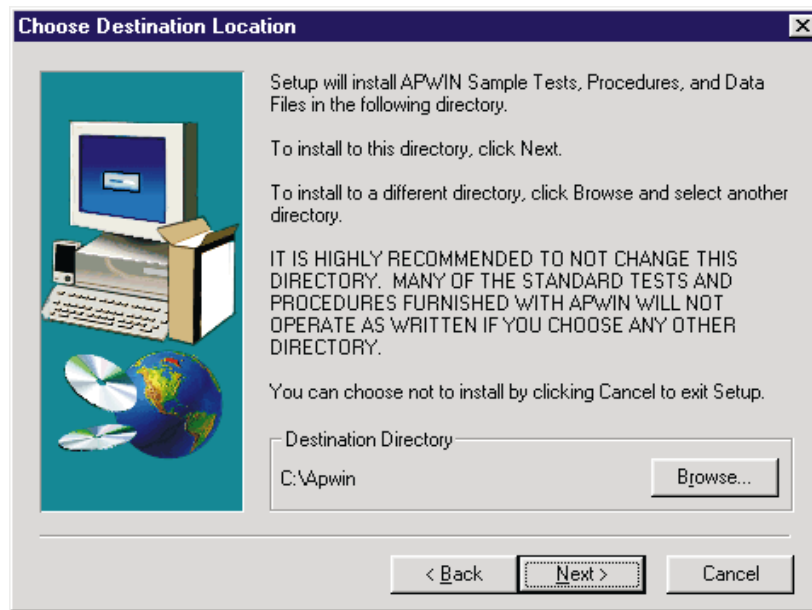

Figure 4-6. Choose Destination Location for sample tests, procedures, and data files dialog box

This screen (Figure 4-6) will suggest a location for all the sample tests, procedures, and data files. If you wish to choose an alternate location, click on the button. When you click the button, the dialog shown in Figure 4-7 will appear.

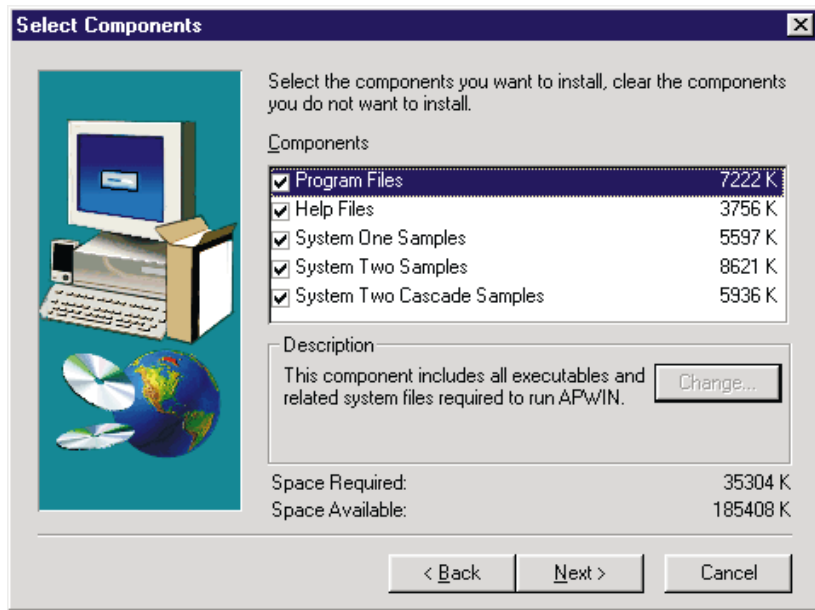

Figure 4-7. Choose Components to Install dialog box

Here you have a choice of what to install and how much space will be required. If you are tight on space or you are re-installing part of the software, you can selectively turn off any of the items shown by clicking on the check boxes (an **X** or **✓** means install, a blank box means don't install).

The next dialog box (Figure 4-8) will suggest a new Program Manager Group name and show a list of all your existing program groups. If you accept the default new name, APWIN will create a new Program Group called Audio Precision APWIN 1.6. If you choose one of the existing Program Groups, the new icons will be added to that group rather than put in a new group.

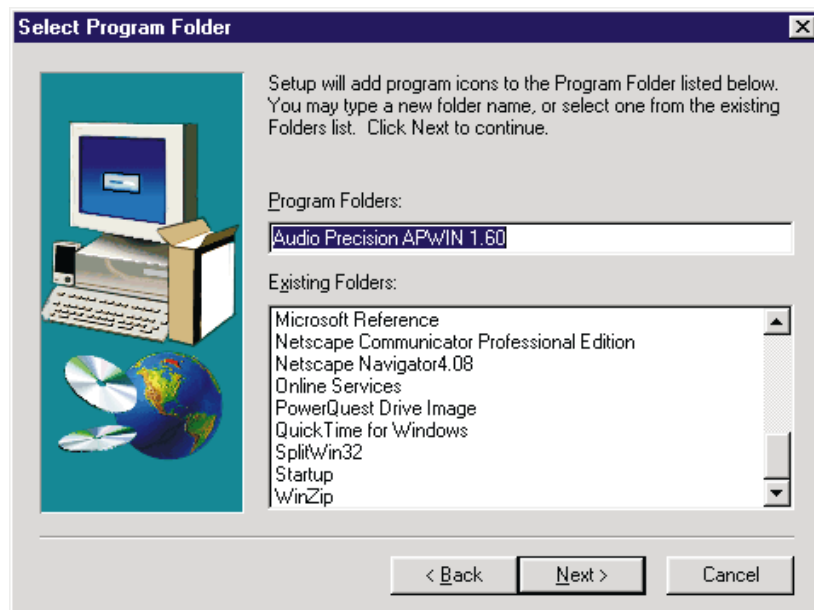

Figure 4-8. Select Program Manager Group dialog box

Now that all of the installation questions have been answered, APWIN will proceed with the installation. You should see the following screen:

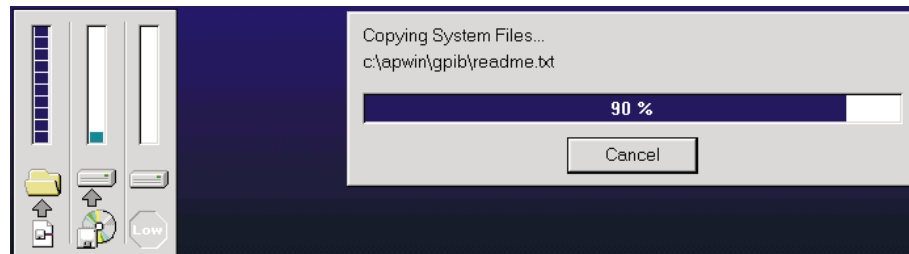

Figure 4-9. Installing progress screen

If you are installing APWIN from diskettes, you will be prompted to insert each diskette as necessary.

After APWIN is successfully installed, the following message window (Figure 4-10) will appear. This completes the installation and you should now be able to start APWIN unless you are using the PCM-WIN PCMCIA interface. If you are using the PCM-WIN card with Windows 95 or 98, you can now insert the PCM-WIN card and Windows 95 or 98 will install the card using the Audio Precision driver.

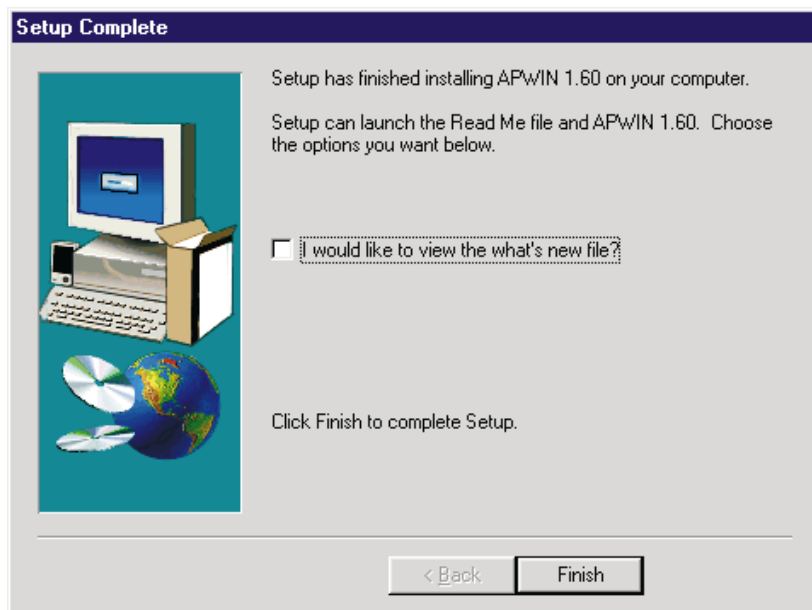

Figure 4-10. Setup Complete message window

4.1 Using PCM-WIN card with Windows 95 or NT

As noted earlier, if your system is to be controlled via a PCM-WIN PCMCIA card, the card itself should not be installed until AFTER the APWIN software is installed. **If you are running Windows 95 or 98,** You may now insert the PCM-WIN APIB card in its slot, and connect its cable as described in Section 3.4. **If you are running Windows NT 4.0,** the computer should be switched off before removing or inserting a PCMCIA card (the Windows NT 4.0 system does not support hot swapping).

5. Getting Started with APWIN

5.1 Starting APWIN

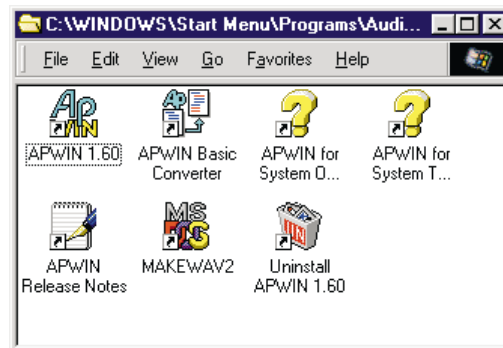

Figure 5-1. APWIN directory window

To start APWIN, double click on the APWIN 1.6 icon shown in Figure 5-1. During startup, APWIN loads several files and checks for the presence of the Audio Precision hardware. It will “look for” an ISA-WIN or PCM-WIN interface card and then for a system. It is able to automatically identify System One, System Two, or System Two Cascade. Depending on the configuration (See section 5.2 and Figure 5-10), the following window may ask you to choose which System to set up for.

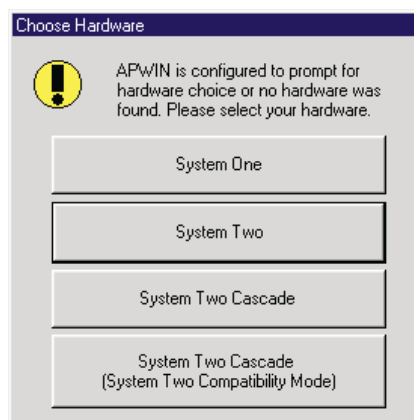

Figure 5-2. Choose Hardware window

If APWIN does not find an interface card and then a system, it will announce this and indicate that it will run in Demo mode (see Figure 5-3). Demo mode allows all program functions to be used except those

requiring communication with the instrument. All reading fields will display random numbers.

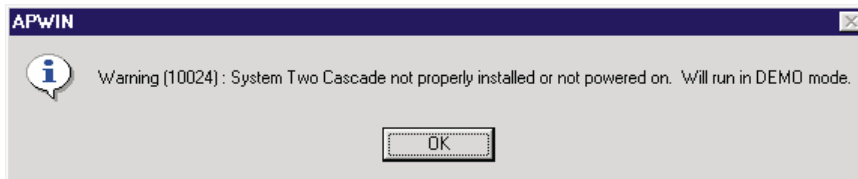

Figure 5-3. Demo Mode warning window

After APWIN is loaded, you can load sample tests, sample procedures, change instrument settings on the various panels, run tests and run procedures. See the User's Manual for complete instructions or use the on-line Help system explained later.

APWIN Tests (named with the extension .AT1, .AT2, or .AT2C) are files that contain the complete setup of the hardware, the layout of the panels, the appearance of the graph, and even measured data from the last-saved results. Loading a test sets up all of these conditions to allow a user to "run" a new test with all hardware and software conditions correctly established. Procedures (named with the extension .APB) are "scripts" that will perform several operations in succession. This might include loading and running a series of tests in sequence, comparing measured results against predetermined acceptance limits, and displaying and/or printing results.

For a quick look at APWIN and an opportunity to see some tests and procedures in action, several examples have been provided. These examples illustrate generic tests such as frequency response, distortion, and noise, and more complex digital audio tests such as codec and AES/EBU interface tests. These procedures load several tests in sequence and illustrate user interaction, limits testing, and graphical presentation.

To load these examples, select FILE from the top menu bar and select OPEN from the list. This will present a secondary selection of file types. Select PROCEDURE to run a short menu-driven procedure that will be able to select all of the available sample tests.

After selecting the file type (Procedure), the Windows File Open dialog will appear (Figure 5-4):

Navigate to the S2 directory (folder) using the normal Windows method. If you installed APWIN with the default file locations, you should find it under the APWIN directory. Double click on the System2.apb procedure. This will then open the Procedure window. At the top of this window will be the Procedure tool bar shown in Figure 5-5 (which may

also be at the top or side of the APWIN desktop if you have this tool bar turned on).

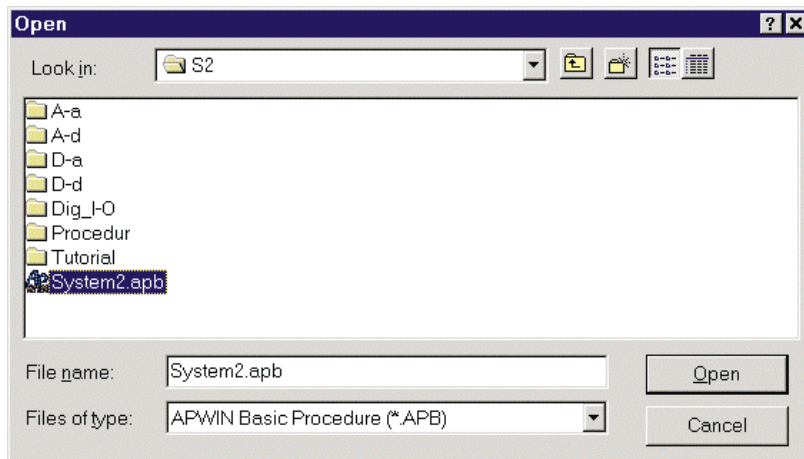



Figure 5-4. Windows 95 File Open dialog box



Figure 5-5. Procedure tool bar

Notice that, as you “park” the cursor over each of the buttons, a “tool tip” pops up, giving the name of the button. Also notice that a brief definition of the button is shown at the bottom of the screen.

Push the Play  button (approximately the middle of the bar) to start this procedure. This will then bring up the following menu box:

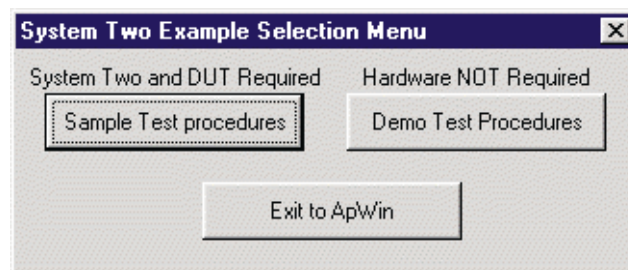

Figure 5-6. System Two Cascade Example Selection Menu window

You can now select from two groups of procedures: Demo Test Procedures includes stored sample data and can be used without a device under test connected (and even without a system connected); Sample Test Procedures requires measurement hardware and the specific

device under test to make actual measurements. After selecting one of these choices, the following menu box should appear:

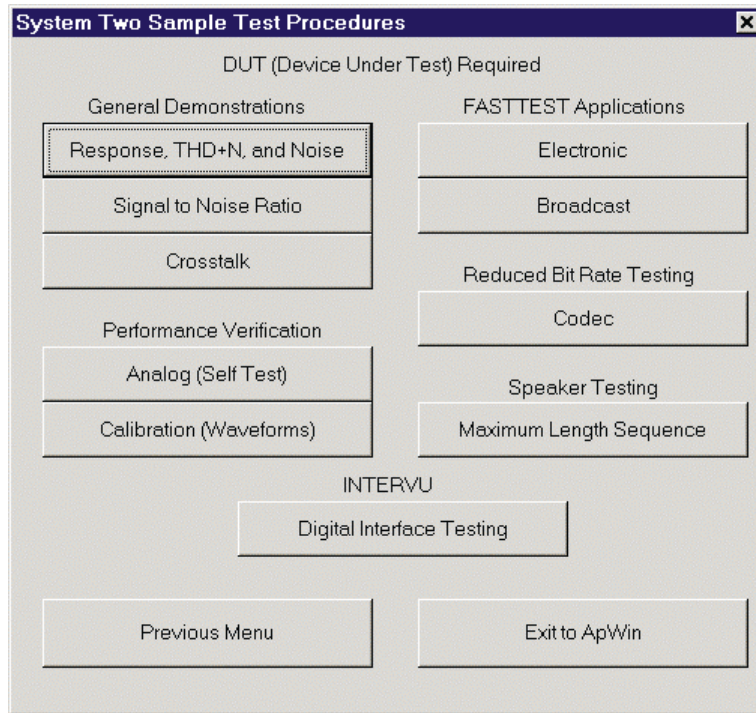

Figure 5-7. System Two Sample Test Procedures window

Here you will find a collection of several sample procedures that will run various illustration tests. Also shown is a Performance Verification procedure that is an excellent example of a detailed test procedure that will make several measurements, test against limits, display measurement graphs, and display a results log. It can also be used to verify the conformance to specification of System One, System Two, or System Two Cascade. This can be quite handy if you ever see unusual test results and would like to be sure that the measurement hardware is functioning correctly.

5.1.1 Automating APWIN Startup

APWIN can be started in a way that forces certain conditions. These include automatically loading a specific test or procedure and automatically running that test or procedure. Adding Options and Switches force these conditions to the command line that launches APWIN. For example, if you follow the APWIN.EXE program with the argument /RUNPRO followed by the procedure name with its path, that

procedure will be loaded and started automatically as soon as APWIN itself starts. If that procedure is a menu selection (similar to the SYSTEM1.APB or SYSTEM2.APB samples provided with APWIN), the user need only choose from a predetermined set of choices to begin testing.

5.1.1.1 Windows 95, 98, and NT

Since Windows starts automatically, put APWIN in the STARTUP group. By selecting PROPERTIES (right mouse button) on the APWIN icon, you can specify a command line option in the TARGET line. This is where to put the /RUNPRO path\filename line. The exact syntax for the target line is:

```
"C:\PROGRAM FILES\APWINBIN\APWIN.EXE" /RUNPRO
C:\APWIN\APWIN\S2\SYSTEM2.APB
```

(this will actually be all on one line)

The quote marks around the first argument are because of the space between PROGRAM and FILES. Change paths and file names to suit your particular setup.

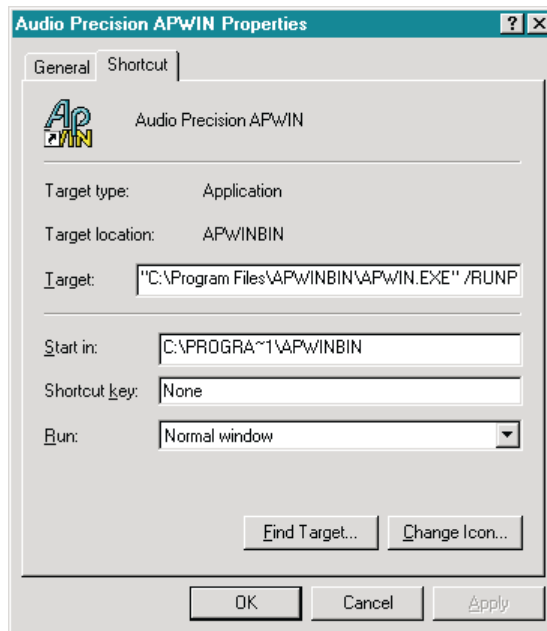

Figure 5-8. APWIN Properties dialog box

The above examples illustrate the use of command line parameters and switches to automate or control the starting of APWIN. Section

5.1.1.2 lists and describes all of the available command line options and switches.

5.1.1.2 Command Line Options and Switches

Syntax:

```
APWIN [TESTNAME.AT1] [TESTNAME.AT2] [PROCEDUR.APB]
[DATAFILE.ADA] [/OPTION] [/OPTION] . . .
```

(again, the above will actually be all on one line), Where

TESTNAME.AT1 is any valid System One test file. When specified on the command line, this test file will be loaded with APWIN.

TESTNAME.AT2 is any valid System Two test file. When specified on the command line, this test file will be loaded with APWIN.

PROCEDUR.APB is any valid procedure file. When specified on the command line, this procedure file will be loaded with APWIN.

DATAFILE.ADA is any valid APWIN data file. When specified on the command line, this data file will be loaded with APWIN.

Note that file extensions (**.AT1**, **.AT2**, **.APB**, **.ADA**) must be supplied.

OPTIONS are any of the following:

S1 forces APWIN to be configured for System One

S2 forces APWIN to be configured for System Two

nologo suppresses the APWIN logo at startup (for faster startup)

runpro causes a procedure loaded with APWIN to run

runsweep causes a test file loaded with APWIN to run the sweep

apib238 forces APWIN to communicate with interface card at address 238

apib298 forces APWIN to communicate with interface card at address 298

apib2b8 forces APWIN to communicate with interface card at address 2b8 (the factory default setting)

apib2d8 forces APWIN to communicate with interface card at address 2d8

Example:

```
APWIN TESTNAME.AT2 PROCEDUR.APB /runpro /apib2b8
```

5.2 User Preferences

APWIN allows the user to customize several aspects of the program. Many of these are in a Configuration dialog that can be accessed under the Utilities menu item. Click on Utilities to drop down a menu list, then click on Configuration to bring up the Configuration dialog box. There are five tabs on this dialog box, as shown in Figure 5-9 through Figure 5-13.

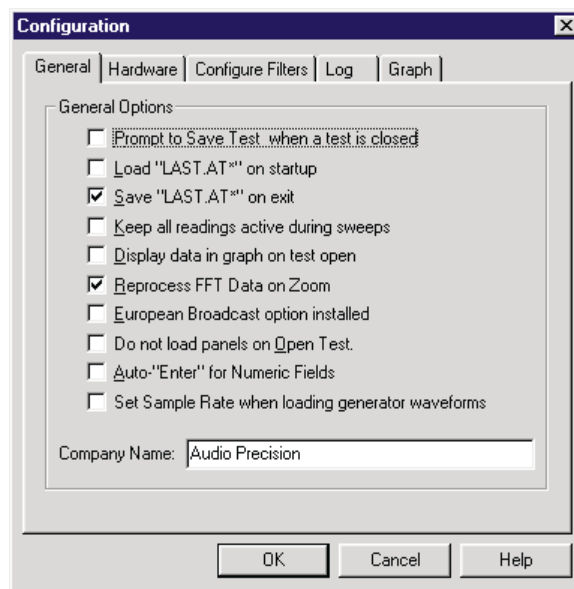

Figure 5-9. Configuration dialog box, General tab

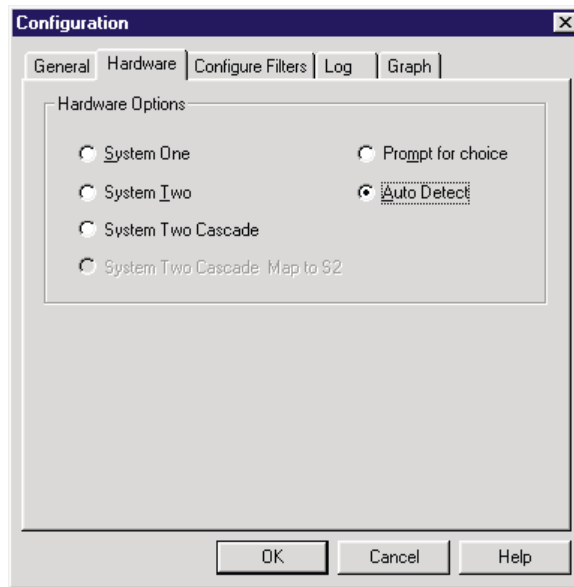

Figure 5-10. Configuration dialog box, Hardware tab

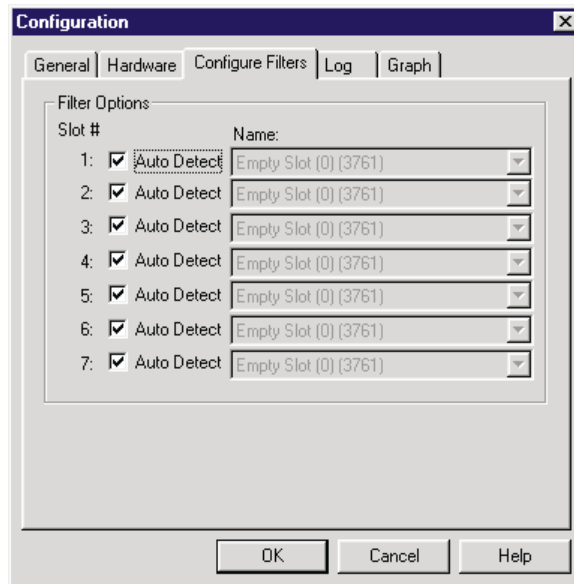

Figure 5-11. Configuration dialog box, Configure Files tab

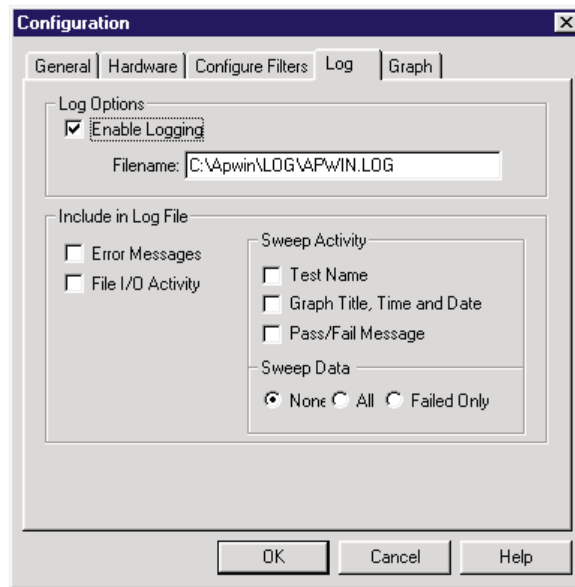

Figure 5-12. Configuration dialog box, Log tab

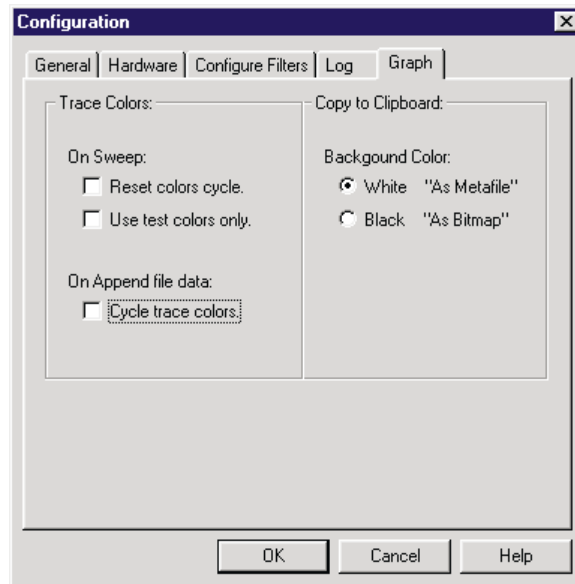

Figure 5-13. Configuration dialog box, Graph tab

Most of the items in these dialog boxes are self explanatory. See the Utilities Configuration section in the MENU chapter of the APWIN User's Manual for a more complete explanation of the various items in this

dialog. The Hardware choices allow the user to override the automatic System detection. If set to Auto Detect, APWIN loads with the correct panels for the attached System (One or Two). If you set the choice to a System different to that connected, the software will run but you will not have proper instrument operation. For example, most readings and generator settings will be erroneous. The forced System One and System Two choices were included primarily to allow System One users to evaluate features on System Two while running in demo mode.

If your system has the EURZ option installed, you must check the European Broadcast option installed box. The EURZ option in the hardware changes the available analog generator output source impedances from the default values of 600, 150, and 50 ohms to 600, 200, and <40 ohms. APWIN needs to know these values in order to set properly the analog generator output level. The rear panel should have a CONFIGURATION label that will identify the presence of the EURZ option.

The “Company” box defines what name will appear on the graph header.

All of the choices entered in this box are saved in a configuration file and will be in place every time the program is loaded.

5.3 APWIN Help

APWIN includes virtually the entire User’s Manual in a convenient on-line format allowing rapid access to answers to operational questions. The help system includes hypertext capability that allows the user to quickly jump between primary and related topics. For a more detailed discussion of how to use the Microsoft Windows Help system which all Windows applications including APWIN use, drop down the Help menu and select Using Help. The following pages illustrate the Help information menus in Windows.

There are two ways to bring up help on a particular subject. One method is to bring up the Contents list and search for a particular topic. A second method is Context Sensitive Help. Simply highlight a particular field on any panel and push the F1 key. A dialog box will pop up with help information on that particular section.

You may click on any of the several topics listed to get specific instructions on that topic. Within each topic there are several places where a deeper treatment of a subject is available. Click on any green and underlined words or sentences to find additional information.

Various other navigation tools are available within the Windows Help system as explained in the How To Use Help dialog, which is accessed via the Windows Program Manager Help menu.

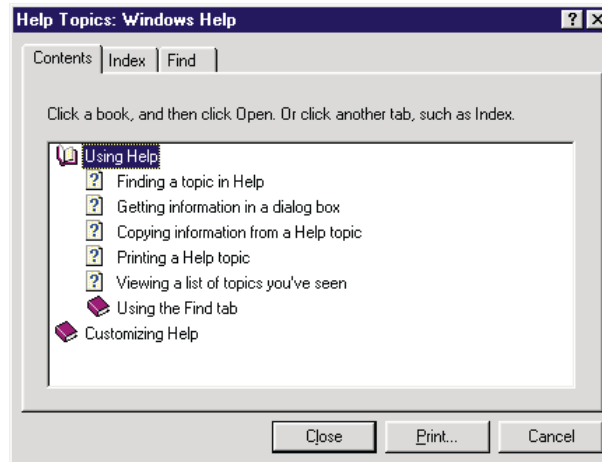

Figure 5-14. Windows 95 Windows Help screen

To bring the APWIN on-line help files to the screen, click on Help and then select Index in the drop down menu list. This will bring up the Contents list of available topics.

5.4 Using Printers with APWIN

APWIN runs under Microsoft Windows and as such is able to use any printer supported by Windows. To select a specific printer that has been previously installed on your computer, select PRINT SETUP under the FILE menu in APWIN. This will show a dialog box that contains a list of all the installed printers including the printer that is currently set as the DEFAULT printer. APWIN will print to either the DEFAULT printer or a Specific Printer depending on which radio button is indicated. To change the Specific Printer, click on the down arrow at the right of the box and select a new printer from the list of installed printers.

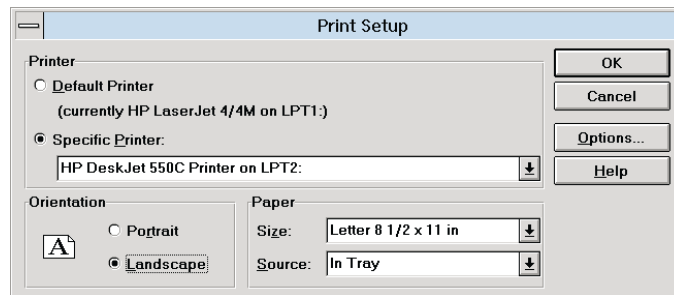

Figure 5-15. Printer Setup dialog box

To install a new printer in Windows (and therefore have it available to all Windows applications including APWIN), you will need a Windows driver for that printer. These are created by the manufacturer of the printer and normally are supplied on a disk with the printer. Additionally, the Windows installation disks include some drivers for several common printers although more recent updated versions of a particular driver are often available directly from the printer manufacturer.

To install a new printer, refer to your Windows documentation for complete instructions. Briefly, click the START button, select SETTINGS, then select PRINTERS. In the dialog box double-click ADD PRINTER>. This will bring up the Add Printer wizard with a long list of printers. If you do not find your particular printer listed and you have a disk from the manufacturer, click the Have Disk button. This will guide you through the process of installation including Setup (which configures the driver for the options installed on the printer) and Connect (which determines to which port the printer will print). *Again, refer to your Windows documentation for more details.*

5.5 Compatibility with S1.EXE

Existing customers familiar with the S1.EXE DOS-based program that has been the user interface since the introduction of System One in 1985 will find substantial improvements in capabilities, ease of use, features, and appearance of APWIN compared to S1.EXE. The powerful graphic capabilities in Windows make a more friendly environment and provide the user the ability to customize many attributes of the user interface to suit personal taste. Graphs can be extensively customized in color, line style or line thickness, size and other visual attributes. Graphs can be printed with any Windows-supported printer including color printers.

APWIN uses a scripting language based on Visual Basic that is far more powerful than the language provided with S1.EXE. This makes it

compatible with a large number of other applications (such as word processors, spreadsheets, and databases). APWIN Basic also has several new commands that have been requested by S1.EXE users.

Coupling this capability with Learn Mode provides a fast and error-free method to create or augment a procedure. The user only needs to enable Learn Mode via the Procedure menu or tool bar selections, and manually go through the test scenario to create a test procedure.

5.5.1 Utilizing S1.EXE Test and Procedures

Test and Procedure files created with the S1.EXE software version 2.10A and later may be imported into APWIN. Under the File menu select the Import – S1.EXE Test or S1.EXE Procedure to convert these files to APWIN Tests and Procedures files.

5.5.2 Remote Operation via RS-232 Interface

In the S1.EXE software users had to create executable (.EXE) files to access the RS-232 port. This type of serial communication via the RS-232 interface can be done totally within APWIN Basic.

5.5.3 S1.EXE Utility Programs

The MAKEWAVE utility has been modified into MAKEWAV2 for use with APWIN. This continues to be a DOS program but can be run under Windows and shows up as an icon in the APWIN program group. This program and its icon are automatically installed by the APWIN installation utility.

The PLOT and POST programs that would take a graphics file produced by S1.EXE and create an HPGL plotter file or Postscript file respectively are not available in APWIN. APWIN has access to the powerful printing features of Windows, supported printers (or plotters) can be driven directly from within APWIN without having to use an external utility. It is also possible to produce HPGL “plotter” and Postscript files from APWIN by simply “printing” to file with an HPGL plotter or Postscript printer selected as the default printer.

5.6 Publishing Graphs

There are several ways to capture a graph, depending upon your requirements. One simple method is to use the Windows clipboard feature. With the graph visible on screen, push Alt + Prnt Scrn to copy the entire screen to the clipboard, or from the menu select Edit-Copy Panel to copy the active window to the clipboard. Then, in any desktop publishing application, from the EDIT menu paste the contents of the clipboard to the location desired.

To save a graph to a file in Windows 95 or NT, from the menu select File-Export-Graphic, and choose the file format: either WMF (Windows MetaFile) or EMF (Enhanced MetaFile). A dialog box will ask for a path and file name.

Another method is to “print” to a file in APWIN. Depending upon the printer driver used, the file can be saved in PostScript or HPGL. Note that it is not necessary to actually have the physical printer connected, it is only necessary to its driver installed in Windows. When you select Print, you will be prompted for a filename. Enter the name and a suitable extension. With either of these latter methods, the resulting file can then be imported into a graphics or publishing program.

5.7 Technical Support

If all else fails and you still have problems installing or running APWIN, call our technical support team for assistance. We can be reached during the following hours Monday through Friday except holidays: 8:30 am to 5:00 p.m. Pacific Time. You can reach us in any of the following ways:

- U.S. Toll Free Phone: 1-800-231-7350
- Phone: (503) 627-0832
- Fax: (503) 641-8906
- Email: techsupport@audioprecision.com
- Web: www.audioprecision.com

When you call or fax please have the following information available:

- Your computer: CPU type and speed (e.g.: 386, 486, Pentium; 33MHz, 66MHz, 90MHz, etc.)
- Amount of RAM installed (typically 8, 12, 16, or 32 Meg)
- System Two configuration SYS-22, SYS-222, SYS-322, (options such as DSP, Dual Domain, BUR-GEN, IMD)

If you call, we strongly recommend that you have the computer keyboard and monitor at the same location as the telephone as we will likely ask you to try several things to assess the situation.

If you need to determine which version of APWIN is loaded, click on the Help menu item and then About APWIN in the pull-down menu. A dialog box similar to the following will appear:

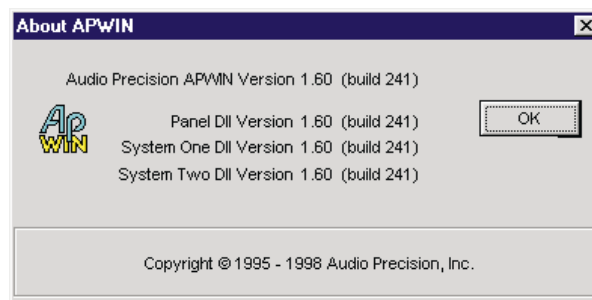

Figure 5-16. About APWIN window (typical-- your version and build numbers may be different)



Audio Precision
PO Box 2209
Beaverton, Oregon 97075-2209
Tel: (503) 627-0832 Fax: (503) 641-8906
US Toll Free: 1-800-231-7350
email: techsupport@audioprecision.com
Web: www.audioprecision.com